

REDUCING GRAMOPHONE SCRATCH

The
**Wireless
World**

MONTHLY
ONE SHILLING

*COVERING
EVERY WIRELESS INTEREST*

NOVEMBER, 1939

LEARNING MORSE

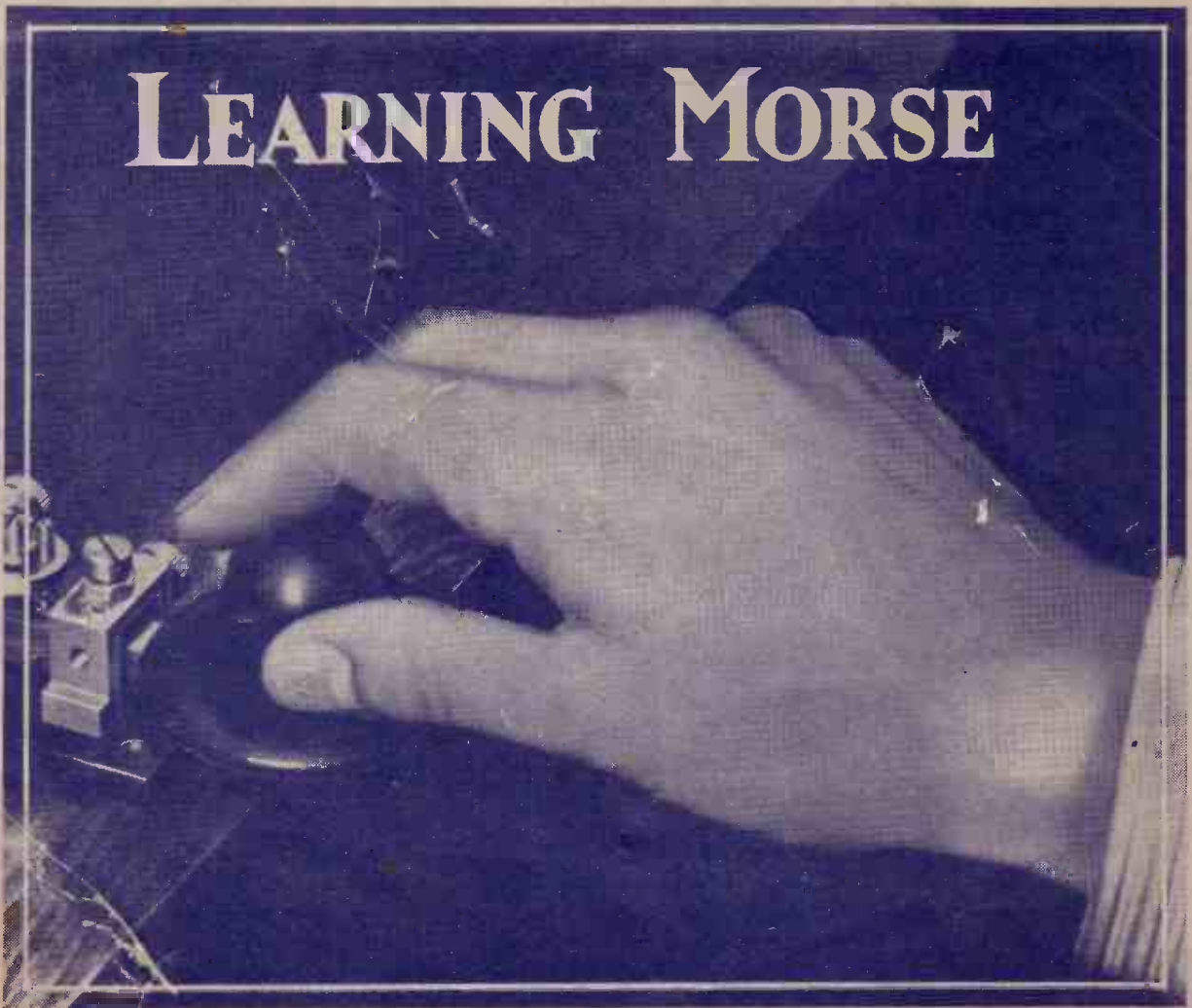

In these days of emergency

*Don't forget that your
radio receiver is more
important than ever.
Rejuvenate it with
new Osram Valves—
keep a spare set handy*

Osram Valves

MADE IN ENGLAND.

A TONIC TO ANY SET

*NOTE: If you have difficulty in obtaining any particular valves,
write to the Osram Valve Dept. of:*

THE GENERAL ELECTRIC CO., LTD.,

Magnet House, Kingsway, London, W.C.2.

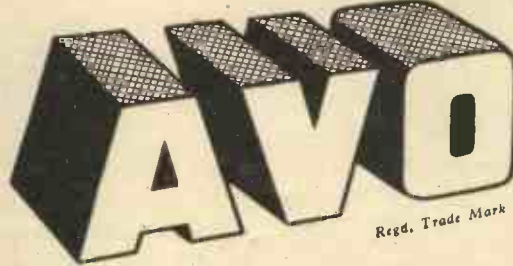

**ELECTRICAL MEASURING
INSTRUMENTS**

BRITISH MADE

WORK of National importance is necessarily making huge demands on the specialised experience of the "AVO" organisation.

We are endeavouring, however, to make every possible provision to assure that, despite this influx of additional and vital work, orders for "AVO" Instruments will be executed with the minimum of delay.

The full range of "AVO" Instruments is being maintained, and customers are urged to anticipate their requirements by placing orders as far in advance as possible of required delivery dates. This will assist us, not only to satisfy the requirements of our trade customers, but will also facilitate the smooth working of our efforts in the National interest.



ACWECO Ltd.
 (The Automatic Coil Winder &
 Electrical Equipment Co., Ltd.)
 Winder House . Douglas St.
 London, S.W.1
 Telephone . . . VICToria 3404/7

PRECISION METERS
that Master every Testing Problem

Mention of "The Wireless World," when writing to advertisers, will ensure prompt attention.

McCLURE HANDBUILT RADIO

The **HAMRAD SUPER COMMUNICATIONS
140 RECEIVER**

This is a first-class set incorporating every desirable feature. The "R" meter works well on both CW and Phone, noise level is exceptionally low while the BFO does not bring up background noise. Sensitivity better than one microvolt on all bands.

BRIEF SPECIFICATION.
13 valves. 9 to 600 Metres, 5 bands, no gaps. Electrical Band-spread. HF on all bands. HF gain control. Two 465 Kc Iron cored IFs. Continuously Variable Selectivity. BFO with variable pitch and zero beat adjustment. Variable delayed AVC, separate valve amplifies DC. Undelayed amplified "R" meter. Differential crystal gate. Two phone jacks. Separate RF Oscillator. Standard rack size. Two AF stages, 6L6 OP. 4,000, 2,000 and 1.5 ohms OP. Dipole and single aerial input. Illuminated dial. Steel cabinet, chromium and black crystal finish.



PRICE **£27 10 0**

MANUFACTURERS' SERVICE

Whatever you want we can make.

Metal Chassis, Turned and Pressed parts, Test-gear, Amplifiers, Radio Receivers, Transformers, Chokes, etc. Also Oxy- and Spot Welding, Stove enamelling, RF Coil Winding in matched sets. All kinds of light general engineering.

QUANTITY ENQUIRIES INVITED

- TUNING UNITS -

Types AGT5 & UT5. 5-waveband Tuning Units of quality, covering 12-35 m.; 30-80 m.; 75-200 m.; 200-550 m.; 660-2,000 m. Tuned RF stage on all bands; triode hexode frequency changer. Full vision scale with spreader drive. Hand built and calibrated. For use with IFs of 465 Kcs. Complete with 4 v. AC valves or 465 Kcs. 6.3 v., 2 amp. E type valves. PRICE **£5.10.0**
3 BANDS from 16 to 2,000 m. £4.10.
4 BANDS from 12 to 2,000 m. £5. 0.
6 BANDS without gaps 4 1/2 to 2,000 m. £8.

Write: Edward Thomas, Facilities Dept.,
JOHN McCLURE LTD. (G6JM)
ERSKINE RD., LONDON, N.W.3. PRImrose 5435-6



PUBLIC ADDRESS EQUIPMENT

for
A.R.P.

in Workshops, Factories and all Industrial or Municipal Undertakings

Send your enquiries to

SOUND REPRODUCER SALES—

BTH RUGBY

THE BRITISH THOMSON-HOUSTON COMPANY LIMITED, RUGBY, ENGLAND



A2771N

It's more than a diary!

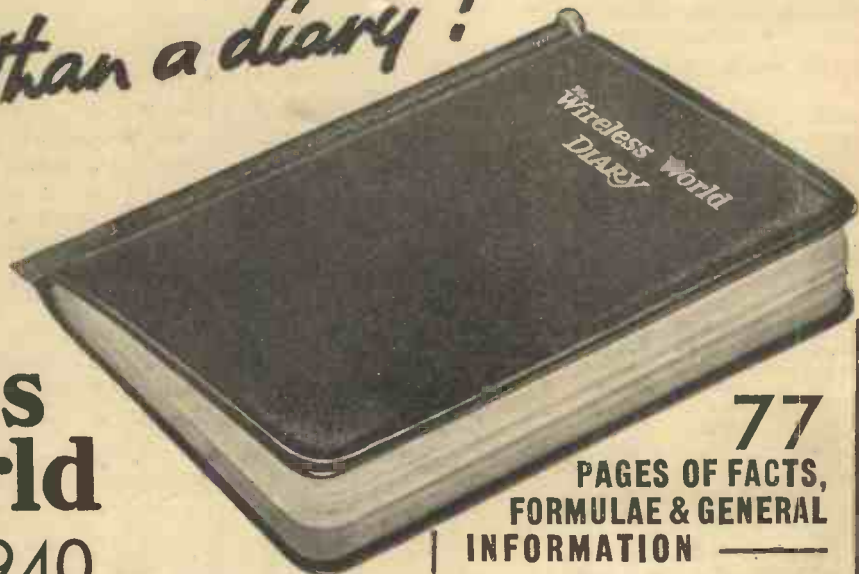

The
Wireless World
DIARY for 1940

NOW ON SALE

77
**PAGES OF FACTS,
FORMULAE & GENERAL
INFORMATION**

that is difficult to memorise but

**ESSENTIAL TO!
THE ENTHUSIAST!**

Size 3 1/2 by 4 1/2 inches, 192 pages. Bound leather cloth, back loop with pencil.

PRICE **1/6** net
By post 1/7

From bookstalls and stationers, or direct from the Publishers.

ILIFFE & SONS LTD., DORSET HOUSE, STAMFORD STREET, LONDON, S.E.1

Mention of "The Wireless World," when writing to advertisers, will ensure prompt attention.

Simmonds Speed Nuts

(PATENTS APPLIED FOR)

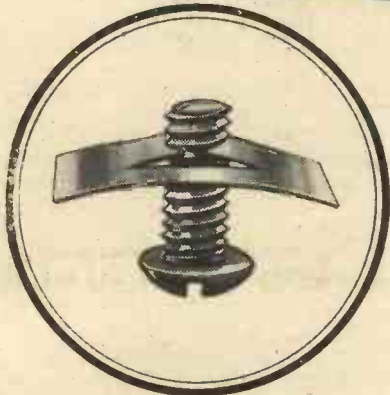

A REVOLUTIONARY SYSTEM THAT WILL CUT YOUR ASSEMBLY TIME & COSTS

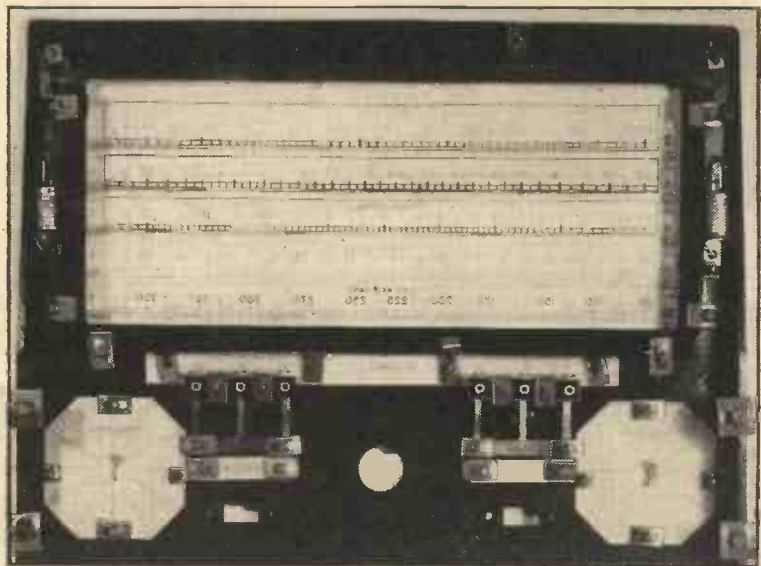

"**R**EVOLUTIONARY" is not too strong a word to describe this ingenious yet inexpensive fastening method. Simplicity itself, yet extremely flexible in adaptation, it reduces the number of operations, enables several parts to be replaced by ONE SPEED NUT, and is invaluable for 'blind' locations. It reduces assembly time and costs, and gives a perfect fastening.

A wide range of standard speed nuts is available from stock for all sizes of machine screws, sheet metal screws, rivets, and plastic studs.

Special types are constantly being designed to suit individual applications and there is practically no assembly problem which cannot be solved by the use of Speed Nuts.

Manufactured by the makers of the famous Simmonds Elastic Stop Nut.

The illustration shows a typical application of the Simmonds Speed Nut for Radio Sets and Cabinet Assemblies.



No. NR374. Round SPEED NUT with sides turned up to accommodate a spanner for tightening the nut side of the assembly.



No. NS1002. Wire clamp SPEED NUT designed with loop for holding wires inside radiosets. This SPEED NUT replaced a three-piece assembly.



No. FR332. Contact holder SPEED FIX. Designed to hold station selector contacts in automatic tuning mechanism. This SPEED FIX eliminated a coil spring, a brass washer, a drilled hole and a cotter pin.

Wireless Manufacturers and Designers are invited to investigate this efficient fastening method. Our development department will be pleased to collaborate and work out the most effective designs to suit your needs.



SIMMONDS AEROCESSORIES LTD
GREAT WEST ROAD, LONDON.



Longleys

Mention of "The Wireless World," when writing to advertisers, will ensure prompt attention.

SOUND SALES IN ACTION!



A.R.P. Sound
Equipment.

COMMUNIQUE No. 1.

Item No. 1. Four weeks after the outbreak of War sees SOUND SALES installed in a modern factory at **WEST STREET, FARNHAM, SURREY.**

Item No. 2. It has already been found necessary to double the area thereof, in order to cope with the ever increasing number of orders from all sources: for the simple reason that in addition to the fact that S.S. Products are recognised as "second to none," S.S. Quality Radio Equipments do not suffer from "Wartime Night Distortion," a peculiar effect which many of you must have found most objectionable.

Item No. 3. SOUND SALES are concentrating on the design and production of:—

- (a) A.R.P. Sound Equipments.
- (b) A.R.P. Reserve Lighting Equipments which are entirely automatic, irrespective of mains supply - - - from £3/10/-.
- (c) Special Transformers and Chokes of all types, from 6 watts to 12 K.V.A.

IT WILL DEFINITELY PAY YOU TO CONSULT SOUND SALES!

Advertisement of Sound Sales Ltd., West St., Farnham, Surrey. 'Phone: Farnham 6461

RADIOMART

G5NI (BHAM) LTD.

THE SHORT-WAVE SPECIALISTS

WE CARRY LARGE STOCKS OF ALL TYPES OF SHORT-WAVE AND COMMUNICATION EQUIPMENT, INCLUDING AMERICAN VALVES

RADIOMART SPECIAL OFFERS! Fully shrouded Transformers by America's largest manufacturer. While they last.

All 230 v. primary and fully impregnated.	
T28708—375/375 v. 150 m/A., 6.3V5A. 2.5V5A. 5V3A.	15/-
T19610—350/350 v. 150 m/A., 2.5V6A. 2.5V2A. 5V3A.	12/6
T7236—375/375 v. 120 m/A., 6.3VCT. 4A. 5V3A.	10/6
T7326—350/350 v. 100 m/A., 6.3VCT. 3A. 5V3A.	8/6
T7307—350/350 v. 80 m/A., 6.3VCT. 2A. 5V3A.	7/6
T7000—320/320 v. 80 m/A., 6.3V4A. 5V3A.	7/6
T6925—320/320 v. 80 m/A., 2.5V6A. 5V3A.	7/6
T464919—10V4A Primary Tapped 110—250 v.	5/6
T1113AB—110/230 v. 500 watt Auto Transformer	29/6
The following chokes are interleaved and impregnated.	
T7007—230 m/A., 135 ohms, 20-8 Hy., cadmium shrouded.	12/6
T7007A—150 m/A., 250 ohms, 30-12 Hy., cadmium shrouded.	12/6
100 m/A., 20 Hy., 500 ohms, unshrouded	4/11
60 m/A., 15 Hy., 250 ohms	1/11

HEAVY DUTY TRANSFORMER for models, bells, etc., 6 v. 3 a., 2/3. 4 m.f. 1,500 v. test 500 v. wkg. oil filled condensers, 2/-.

HEAVY DUTY Mains Transformer, worth 45/- 350-350. 150 m/A. 4 v. 2.5 a. CT, 4 v. 6 a., CT, 12/6; 300-300 v., 80 m/A., 4 v. 3 a., CT, 4 v. 2 a., CT, 6/6. Moving Coil Speaker Transformers power, pentode or push pull, 1/11. WB Heavy duty ditto, 2/11.

GANG CONDENSERS with Airplane Dial, 8 and 80-1. Cost 35/-. Few only. 4/11.

W.B. 8in. PERMANENT MAGNET SPEAKERS AT ONE-THIRD COST. Extension Type (no Transformer), 8/11. Standard Type (with Transformer), 10/6. Energised 8", 1,200 ohms with Transformer, 6/11.

PUSHBACK Wire, 6 yds., 6d., heavy, 9d. Resin-cored Solder, 6ft., 6d.; Screened Flex. single, 6d. yd.; twin, 9d. yd. Assorted Solder Tags, 6d. packet. Humdimmers, 6d. each. Centralab pots, all sizes, 1/6; switched, 2/-; tubular fuses, 2d. Milliammeters, 25 m.a. upwards, 5/6.

VALVES: Reliable replacements for all types, British and American, showing saving of over 50 per cent.

OUR NEW 66-PAGE MANUAL, packed full of valuable information. Communication receivers, transmitters, etc., 71d. post free.

THE NEW RAYMART CATALOGUE shows dozens of New Short-wave Components and is yours for 1jd. post free.

TRADE ENQUIRIES solicited for all types of communication equipment, receivers, etc.

RADIOMART 44, HOLLOWAY HEAD, BIRMINGHAM
G5NI (Birmingham) Ltd.



ECONOMICAL

in use—as reliable as the tide

Westinghouse
METAL

RECTIFIERS

Never need replacing and their use, either in battery or mains receivers, cuts down the power consumption of the set. Send 3d. to Dept. W.W. for a copy of "The All Metal Way."

WESTINGHOUSE BRAKE & SIGNAL Co. Ltd., Pew Hill House, Chippenham, Wilts.

Mention of "The Wireless World," when writing to advertisers, will ensure prompt attention.



CATHODE RAY TUBE

TYPE 4096 A

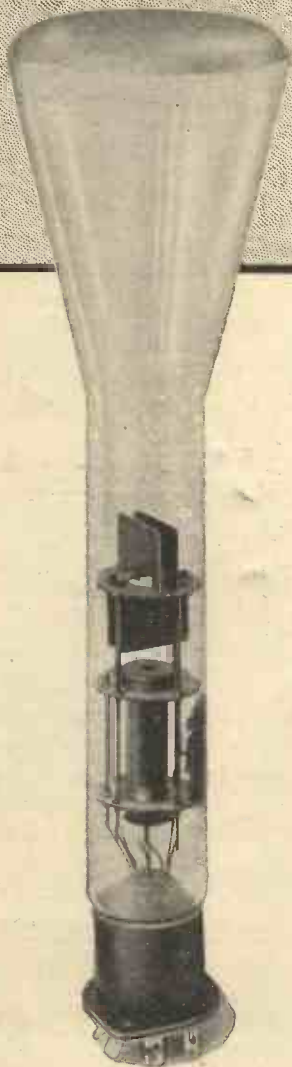

THE 4096 A Cathode Ray Tube is a hard vacuum tube suitable for use with anode voltages from 800 to 2,000 volts and has a screen diameter of 3 inches. The screen provides a blue spot of high actinic value necessary for photographic purposes and, in addition, owing to its intense brilliance, is suitable for visual work.

Efficient electrostatic screening is ensured by the internal coating of the tube with aquadag while the connections to the "Y" plates are brought out to separate pins, thereby facilitating the use of balanced circuits and providing for improved focussing.

The cathode is indirectly heated and thus the heater may be supplied with raw A.C. This tube is fitted with an American type octal base.

The popularity of this tube has now enabled us to offer it at the attractive price of

£2.10.0 NETT

Delivery in Great Britain or Northern Ireland.

Standard Telephones and Cables Limited

NORTH WOOLWICH

LONDON, E.16

Telephone: Albert Dock 1401.

BRANCHES AND REPRESENTATIVES THROUGHOUT THE WORLD

Mention of "The Wireless World," when writing to advertisers, will ensure prompt attention.



Chassis equipment
sold separately if
desired.

Wholesale
Enquiries
invited.

The New

AMBASSADOR RADIOGRAM

For the man who likes Radio and Gramophone combined this new AMBASSADOR model is undoubtedly something for earnest consideration. An entirely new style of cabinet design, affording accommodation for storing up to 200 10" and 12" records, is a unique feature. A powerful six-valve three-band Superhet. receiver with R.F. stage covers from 12.5/52m., 175/550m. and 1,000/2,000m. MAZDA valves—Band spreading on short waves—and a host of other essential features are described in literature available free on request.

PRICE £24:5

Details from

AMBASSADOR RADIO WORKS
HUTCHINSON LANE, BRIGHOUSE, YORKS.
Tel. 283.

M·R· SUPPLIES

present the following opportunities in first-class, up-to-date
AMPLIFIERS AND ELECTRICAL EQUIPMENT
Brand new goods. Finest makes. Real bargain prices.

GRAMPIAN "New Stylis" 10-watt AC/DC AMPLIFIERS (11 only). Complete Portable Equipment in strong blue-leather covered cabinet, 14½" by 16½" by 9½", with loose weather-proof cover. Two fader/mixers and tone control. With fine 6-guinea Gramplan M/Coil Microphone and chromium Floor Stand. Built-in auditorium speaker and all leads, plugs, etc. Magnificent performance—ready for use. (List £18/18/-). We offer the limited number at only £12/18/6 each.

GRAMPIAN Universal AC/DC 14½-watt AMPLIFIERS (3 only). Fitted two fader/mixers and tone control. Complete with eight valves—four output pentodes in parallel push-pull. Amplifier only. (List 18 Gns.) Offered at £8/17/6 each.

G.E.C. 1582 High-quality "all-purpose" POWER AMPLIFIERS 200/250 volts A.C. operation. Switching for mike, radio and gram. inputs. Multi-matching output for all speaker arrangements. U.D.O. 6/8-watts—ideal for domestic or communal use. Complete with four Osram valves. (List £21). Last few of these fine amplifiers at only £7/18/6.

G.E.C. 1545 SCHOOL or HOSPITAL RECEIVERS. AC/DC Superhet in fine oak cabinet. These fine laboratory-built receivers are listed at £24 and are ideal for all domestic and communal reception. Multi-matching output (6-watts) for up to five speakers or 400 pairs' phones. Complete with 7 Osram valves (2 X N31 output). Last 5 of these at only £7/10/- each.

CROSLY MOBILE 6-VOLT SUPERHET CHASSIS. Tuning 15 to 555 metres in three bands. Operating entirely from a 6-volt battery. Five-colour 7" dial (time-log). Ideal for A.R.P. and other uses independent of mains supply. Output 3-watts. Complete with 6 valves and built-in vibrator. New, very slightly soiled. £5/10/- each.

EDISWAN "TUNGAR" BATTERY CHARGERS 200/250 v. A.C. Charging from 2 to 30 volts up to 5 amps. In steel cabinet with 0/5 Ammeter. Last few 12-guinea model, perfect, slightly soiled, £3/18/6 each.

"PHILCO" VALVE TESTERS. Fine opportunity. Complete with two separate 20-socket valve panels for all British and American Valves. Complete and brand new £18 instruments for £9/10/- Last five.

ELECTRIC MOTORS. "Century"—Anest make and type. 1/4th H.P., A.C. 200/250 volts, repulsion-induction, self-starting, 1450 r.p.m., very silent running, 49/6. Also "Century" 1/8th H.P. split-phase, self-starting, for 100/120 volts A.C., 35/- Various others, A.C. and D.C.—please enquire.

PANEL METERS (Precision). Measure A.C. and D.C. with equal accuracy. Amperes, 0/1.5, 0/3, 0/5 and 0/10—any one, 5/9. Volts, 0/10 or 0/250, either 6/11. Millamps, 1/20, 0/50, or 0/250, any one, 6/11. 2½" diameter, black finish, flush mounting.

G.E.C. GRAMOPHONE PICKUPS, with arm, 18/6 model for 6/6. PUSH-BUTTON SWITCHES, banks of 6 D.P. switches, with mounting brackets, 2/11. PIEZO-CRYSTAL ELEMENTS, for construction of microphone, pickup, etc. 2½" dia., fitted struts, 6/11. MINIATURE P.M. M/COIL UNITS, only 3" diameter. 15-ohms imp. Ideal mike or extension speaker, 11/6. G.E.C. MIKE TRANSFORMERS for all carbon mikes, fully shrouded with plug type terminals, 6/6.

All rail goods sent carriage forward. Others post paid. Order with confidence from the firm that never disappointed a customer.

M·R· SUPPLIES, 68, New Oxford St., London, W.C.1. Phone: MUS. 2958.

GARRARD POPULAR RECORD CHANGERS

One of the many dependable and robust Record Changers all reflecting "GARRARD" craftsmanship and precision engineering.

Model R.C. 10 **£6.0.0**

Retail

(A.C.—100/250 volts, 50/60 cycles.)



The GARRARD ENGINEERING & MANUFACTURING Co. Ltd.
SWINDON, WILTS.



LEARNING MORSE

AN EASY METHOD OF MASTERING
THE INTERNATIONAL SIGNAL CODE

6d. net. By Post 7d.

Published from the Offices of "THE WIRELESS WORLD"
ILIFFE & SONS LTD., DORSET HOUSE, STAMFORD STREET, LONDON, S.E.1

Mention of "The Wireless World," when writing to advertisers, will ensure prompt attention.



Are we downhearted?

NO. We're having our troubles the same as you are, but we're overcoming them as fast as they arise — and before they arise whenever possible. So this announcement is just to say that we're still here, still very active indeed and still (in our humble opinion) giving the finest value in condensers and resistances to-day.

DUBILIER

DUBILIER CONDENSER CO. (1925) LTD., DUCON WORKS, VICTORIA ROAD, NORTH ACTON, LONDON, W.3



Mention of "The Wireless World," when writing to advertisers, will ensure prompt attention.

C.R.C. 153

NEWS round the clock . . .
NEWS round the world
HALLICRAFTERS
Communication-Type
RECEIVERS are NEWS!

HALLICRAFTERS Communication-type Receivers are a range of specialised precision instruments built to exacting design specifically for the reception of short and ultra-short-wave stations. These instruments are recognised by leading authorities, and used throughout the world, where the utmost sensitivity, selectivity and range are essential. There are 25 to 30 models of these receivers in our London Store, ranging in price from £10 to well over £150 for the Super Dual Diversity type. (Prices subject to an increase of 15 per cent. as a result of emergency conditions.)

Ask for new **RECEIVERS CATALOGUE.**

WEBB'S THE HOME OF THE
LONDON SHORT WAVE ENTHUSIAST
14 SOHO ST., OXFORD ST., W.1

(Open 9.30 a.m. to 4.30 p.m.)
Telephone: Gerrard 2089

Emergency Branch for all correspondence
58, Victoria Street, St. Albans, Herts.

Birmingham Depot:—41, CARRS LANE Phone: Mid 5669

GALPINS ELECTRICAL STORES

75, LEE HIGH RD., LEWISHAM, LONDON, S.E.13

Telephone: Lee Green 5240.

- MACKIE MOTOR GENERATOR, 220 volts 3.35 amps. D.C. input, 10 volts 30 amps. D.C. output, 37/6. C.F.
- CROMPTON DYNAMOS, 4-pole shunt wound, 1,750 r.p.m., 220 volts 10 amps., 70/-.
- Newton Motor Generator, 220 volts D.C. to 16 volts 10 amps. D.C., 30/-.
- CROMPTON MOTOR GENERATOR, 220 volts D.C. to 500/750 volts 200 m/A. D.C., 40/-.
- DYNAMO BY ELECTROMOTORS, 400 revs., 100 volts 10 amps., shunt wound, 90/-.
- SMALL MOTORS. Beckenham Motor Generators, 220 volts D.C. to 500 volts 300 m/A. and 12 volts 12 amps. All three coupled together on slide rails. 35/- each. C.F.
- E.C.C. SHUNT WOUND DYNAMO, 100 volts 50 amps., 1,500 r.p.m., £6/10/-.
- MACKIE ALTERNATOR, 120 volts D.C. input, 65 volts 1 ph. 150 cycles 1 kW. output. Vertical type, 45/-.
- MACKIE DYNAMO, shunt wound, 75/00 volts 8/10 amps., 1,500 r.p.m., 55/-.
- C.A.V. SHUNT WOUND DYNAMOS, 25 volts 8 amps., 1,750 r.p.m., 32/6. C.F.
- HIGH-VOLTAGE TRANSFORMERS for Television, Neon, etc. 200/240 volt 50 cy. 1 ph. primary, 5,000 and 7,000 volts secondary, enclosed in petroleum jelly. Size: 5 1/2 in. x 4 1/2 in. x 4 1/2 in., 7/6 each, post 1/-.
- DI. Skeleton type, 5/6, post 9d. All brand new.
- EVERSHED EX-R.A.F. HAND-DRIVEN GENERATOR, in new condition, 800 volts 30 m/A, and 6 volts 2 1/2 amps. D.C. Useful as megger genies and all test work. 20/- each, post 1/6.
- ELLIOTT MOVING COIL METER MOVEMENT, first grade, approx. 2 m/A., full scale of 6 inches, 10/6 each, post 1/-.
- P1 STANDARD TELEPHONE PUSH-BACK CONNECTING WIRE (new), 220-yard coils, 12/6, post 1/-.
- STANDARD TELEPHONE MAINS TRANSFORMERS, input 200/250 volts, output 250/0/250 volts 200 m/A. 3 x 4 volt windings and a 50-volt winding. 12/6 each.
- THE "RACON" MOVING COIL HORN SPEAKER UNITS, 15-ohm Special Coil, G-volt, fitted handle, 15 watts, 15/- each, post 1/6.
- EX-NAVAL 1-VALVE BUZZER WAVEMETERS, 200/24,000 metres. Complete in solid leak case. Size: 15 x 10 x 8 (less valve). Turner unit enclosed in copper tank (Sullivan high note buzzer). Price, 7/6 each. C.B. Not sent C.O.D.
- EX-G.P.O. GLASS TOP RELAYS, Type B. Useful as Keying Relays, 5/- each, post 6d. Also a few only that need points, which are easily fitted, 2/6 each. P.F.
- T.C.C. 2,000 MF. ELECTROLYTIC CONDENSERS, 50-volt working (brand new), 5/- each, post 6d.
- STANDARD TELEPHONE BELL WIRE, all brand new. 150-yd. coils, twin 22 gauge, 4/-, post 9d.; 250-yd. coils, single 16 gauge, 4/-, post 1/-; 300-yd. coil single 22 gauge, 3/-, post 6d.
- MOVING COIL METER MOVEMENTS for recalibrating into multi-range meters. Low m/A. deflection. 2 1/2 in. dial, 5/- each; 4 in. and 6 in. dial, 6/- each. Post 1/-.
- All these meters are by good makers—Elliott, E. Edgcombe, etc.)
- G.P.O. MULTI-CONTACT RELAYS, single coil, 3/6; twin coil, 4/6; triple coil, 5/6. All coils separate working, various resistances.

Why Solon Electric
Soldering is easier



SAVES TIME

Ordinary Iron requires continual re-heating. The Solon maintains constant heat.

No need to re-heat a Solon—15 hours' continual use requires only 1 unit. Switch on, ready in 4 minutes. Solon soldering is better, too! The bit remains clean because it is electrically heated by the element inside the bit.

Supplied complete with Resin-cored Solder, Flex and Lamp Adaptor 8/6

Solon Resin-cored Solder 6d. per reel.

It's Easier with a

SOLON
Electric
SOLDERING IRON



W. T. Henley's Telegraph Works Co. Ltd.
(Dept. 3/E), Holborn Viaduct, London, E.C.1.

ALL-POWER
MAINS EQUIPMENT SPECIALISTS

We are equipped and qualified to handle quantity orders for Chokes and Transformers of every type—Power, Output, Intervalve and Line.

MANUFACTURERS' ENQUIRIES ARE INVITED.

For Efficiency, Reliability and Speedy Delivery get in touch with

ALL-POWER TRANSFORMERS LTD.

Contractors to H.M. Govt. and the Services.

8a, Gladstone Road, Wimbledon, S.W.19. LIBerty 3303.

THE BEST WAY to LEARN MORSE

"MASTERS" INSTRUCTIONAL RECORDS Prepared by an ex-R.A.F.V.R. Signal Instructor, these records contain messages at a speed from 2 to 15 words a minute. Details on Request.

Price 3/- each or Complete Set of Three 8/-.
C. E. MASTERS Lincoln House, Brookhill Road, Copthorne, Nr. Crawley, Sussex.



Mains Transformers as specified for The Wireless World High Quality Communication Receiver Type WW51-45/-.

W. BRYAN SAVAGE LTD.

Westmoreland Rd., London, N.W.9. Phone: Colindale 7131

FINAL OFFER OF WHISTLE-REJECTORS, SCRATCH FILTERS, DISC CHOKES AND H.F. CHOKES

Manufacture being temporarily suspended due to other engagement of plant, and limited stock exists—order now.

Whistle Rejectors V.5 and V.6, are of the "Balance" type, giving a complete rejection of any Whistle with extremely narrow "V-Cut" not affecting quality the slightest—no sheer quality set can do without one. V.5 for Anode Circuits, V.6 for Grid Circuits, etc. Prices: V.5, 30/-, V.6, 28/-.



Graphs and full matter of these and other products on request.

YOU MUST ORDER NOW
POSTLETHWAITE BROS.
"Kinva Works," KInver, Staffs.

WARD WE MANUFACTURE:

ROTARY CONVERTERS DC/AC for operating P.A. amplifiers, Radio Receivers, etc.
DC/DC ROTARY TRANSFORMERS, SMALL ALTERNATORS, SMALL D/C MOTORS, H.T. GENERATORS. MAINS TRANSFORMERS up to 10 k.v.a. PETROL ELECTRIC generator sets up to 50 k.v.a.

BATTERY CHARGERS for private and industrial use. We can also handle general small engineering work.

Full details of any of the above upon request
CHAS. F. WARD
46, FARRINGDON ST., LONDON, E.C.4
Telephone: Holborn 9703.

**Special Purchase
OF
"AIR WARDEN"**

**5-VALVE MIDGET RECEIVERS
for 200-250 v. A.C. Mains.**

Completely self-contained in highly polished wood cabinet 12 x 9½ x 9 ins. with built-in Moving Coil Speaker.

Wave range 190-550 metres,
Usual Price. £6-6-0.

OUR PRICE 55/-

The Ideal "Stand-by" Receiver.

**PREMIER SHORT-WAVE KITS
for OVERSEAS NEWS.**

Incorporating the Premier 3-Band S.W. Coil, 11-86 Metres without coil changing. Each Kit is complete with all components, diagrams and 2-volt valves. 3-Band S.W. 1 Valve Kit, 14/9. 3-Band S.W. 2 valve Kit, 22/6.

DE LUXE S.W. KITS

Complete to the last detail, including all Valves and coils, wiring diagrams and lucid instructions for building and working. Each Kit is supplied with a steel Chassis and Panel and uses plug-in coils to tune from 13 to 170 metres.

- 1 Valve Short-Wave Receiver or Adaptor Kit ... 20/-
- 1 Valve Short-Wave Superhet Converter Kit ... 23/-
- 1 Valve Short-Wave A.C. Superhet Converter Kit ... 26/3
- 2 Valve Short-Wave Receiver Kit ... 29/-
- 3 Valve Short-Wave Screen Grid and Pentode Kit ... 68/-

**The New Premier
"STAND-BY" 2-VALVE KIT**

Specially designed for Home Service and other medium wave reception.

Complete Kit of Parts for a S.G. detector and Pentode Output set for 250-550 metres. Including ready drilled chassis and panel, all components, 2-volt valves and full constructional diagrams. Complete Kit with Valves ... 19/6

PREMIER GENERAL PURPOSE TRANSFORMERS.

Introducing a new range of popular priced transformers, compact and efficient. Dimensions, 2½ x 2½ x 2½ ins. with terminal connections.

Type PPI. Push-pull Intervalve Transformer, ratio 3 : 1 overall, maximum current 6 ma. Split secondary winding ... 6/6

Type CBI. Class B Driver Transformer, ratio 1.5 : 1 overall. Suitable for use with all Standard Class B valves ... 6/3

Type MRI. Universal Output Transformer. Primary current 36 ma. Single-end or 72 ma. push-pull. Primary and secondary are tapped to provide eleven ratios. Maximum power capacity 4 watts ... 6/6

**PREMIER RADIO
—AS USUAL!**

FOR RUSH DELIVERY, MARK YOUR ORDER "ATTENTION A.M."

PREMIER BATTERY CHARGERS for A.C. Mains. Westinghouse Rectification complete and ready for use. To charge 2 volts at ½ amp., 11/9; 6 volts at ½ amp., 19/-; 6 volts at 1 amp., 22/6; 12 volts at 1 amp., 24/6; 6 volts at 2 amps., 37/6.

HUGE PURCHASE

OF

U.S.A. MAINS TRANSFORMERS

at less than pre-war prices.

Input 110 v. + 220 v. A.C. Output 325-325 v. 120 mA. 5 v. 2 amps. C.T. 6.3 v. 2-3 amps. } **7/6**
EACH

Input 230 v. A.C. Output 325-325 v. 75 mA. 5 v. 2 amps. 6.3 v. 2-3 amps. C.T. } **6/6**
EACH

Input 200-250 v. A.C. Output 250-250 v. 60 mA. 4 v. 2 amps. 13 v. 1 amp. } **3/6**
EACH

Input 100-250 v. A.C. Output 300-300 v. 80 mA. 4 v. 5 amps. C.T. 4 v. 1 amp. } **6/11**
EACH

PREMIER 1940 HIGH FIDELITY AMPLIFIERS

Ideal for A.R.P. Alarm Systems.

A new Complete Range of 7 High Fidelity P.A. Amplifiers for A.C. or A.C./D.C. Mains operation.

	Completely Kit of Parts with Valves.	Wired and Tested
3-watt A.C. Amplifier	£2 - 6 - 6	£3 - 4 - 0
3-watt A.C./D.C.	£2 - 6 - 6	£3 - 4 - 0
6-watt A.C.	£6 - 2 - 6	£7 - 0 - 0
8-10-watt A.C./D.C.	£5 - 5 - 0	£6 - 2 - 6
15-watt A.C.	£6 - 14 - 0	£8 - 2 - 6

Black Crackle Steel Cabinet 15/- extra.

REPLACEMENT VALVES FOR ALL SETS.

EUROPA MAINS VALVES. 4 v. A.C. Types A.C./H.L., A.C./L., A.C./S.G., A.C./V.M.S.G., A.C./H.P., A.C./V.H.P., A.C.P., all 5/3 each. A.C./Pens, L.H., 6/6; A.C./P.X.4, 7/3; Oct. Freq. Changers, 8/6; Double Diode Triodes, 7/6; 3½-watt D.H. Triode, 7/6. 350 v. and 500 v. F.W. Rect., 5/6. 13 v. .2 amps. Gen. Purpose Triodes, 5/6; H.F. Pens. and Var.-Mu. H.F. Pen., Double Diode Triodes, Oct. Freq. Changers, 7/6 each. Full and Half-wave Rectifiers, 6/6 each.

TRIAD U.S.A. VALVES.

We hold the largest stocks of U.S.A. tubes in this country and are sole British Distributors for TRIAD High-grade American Valves. All types in stock. Standard types, 5/6 each. All the new Metal-Class Octal Base tubes at 6/6 each. 210 and 250, 8/6 each.

CLEARANCE LINE U.S.A. VALVES.

U.S.A. Types, 24, 30, 41, 39/44, 35/51, 55, 56, 57, 58, 71, 77, 78, 85, 2A5, 2A6, 2A7, 2B7, 6A7, 12Z3, 210, 250, all 2 for 3/-.

PREMIER S.W. H.F. Chokes, 10-100 metres, 9d. each. Pie-wound, 1/6 each. Screened, 1/6 each. SHORT-WAVE COILS, 4- and 6-pin types, 13-26, 22-47, 41-94, 78-170 metres, 2/- each, with circuit. Premier 3-band S.W. coil, 11-25, 19-43, 38-86 metres. Suitable any type circuit, 2/11.

UTILITY Micro Cursor Dials, Direct and 100 : 1 Ratios, 4/3.

SHORT-WAVE CONDENSERS

Trolitul insulation. Certified superior to ceramic. All-brass construction. Easily ganged.

15 m.mfd.	1/9	100 m.mfd. ...	2/3
25 m.mfd.	2/-	160 m.mfd. ...	2/6
40 m.mfd.	2/-	250 m.mfd. ...	2/11

PREMIER 1940

"5 v. 5" COMMUNICATIONS RECEIVER

A 5-valve Superhet, covering 12-2,000 metres in 5 wave bands.

- Beat Frequency Oscillator
- 2-Spread Band-Spread Control
- A.V.C. Switch
- Illuminated Band-Spread Dial
- Send-Receive Switch
- Iron-Cored IF's
- Phone Jack
- Over 4-Watts Output

Provision for single wire or Di-pole Aerial. International Octal Valves for 200-250 v. mains (A.C.). Built into Black Crackle Steel case providing complete screening, 10½ in. Moving Coil Speaker in separate steel cabinet to match.

Receiver, Complete with all tubes and Speaker **£9 9 0**

NOW READY! OUR GIANT 1940 ILLUSTRATED CATALOGUE AND VALVE MANUAL — OVER 100 PAGES PRICE 6d.

PREMIER RADIO CO.

ALL POST ORDERS to: JUBILEE WORKS, 167, LOWER CLAPTON ROAD, LONDON, E.5 (Amherst 4723).
CALLERS to: Jubilee Works, or 169, Fleet Street, E.C.4 (Central 2833) or 50, High Street, Clapham S.W.4 (Maccaluy 2381).

News from Abroad

This extract from *THE WIRELESS WORLD* "Editorial Comment," September 14th issue, indicates what you are missing if your Receiver has not got *really efficient* Short-wave bands.

Short Waves have certainly come into their own and are very much "in the news."

AMERICA — AUSTRALIA — FRANCE — GERMANY — ITALY — RUSSIA all give news in English. It is informative, interesting and sometimes (from Germany) unconsciously humorous. But you must have a *first-class* set, one which is carefully designed, so that you can get the best from *all* wavelengths—short, medium and long.

"Complaints have been voiced in Parliament that there is too much delay in giving us news of important happenings . . . we submit that the authorities should keep a close watch on foreign broadcasting with a view to considering whether there is any point in withholding from our own people an item of news that has already been transmitted from abroad."—*Vide Wireless World, Sept. 14th.*



VIDOR 1940 RADIO

at the prices mentioned, represent values never before approached. The reason? Concentration on a limited number of models! Every one is *outstanding* in its own class both as regards Quality of Reproduction and workmanship.

VIDOR

ALL-WAVE SUPERHET

MODEL 323.

Brief Specification.

6 Valves, including "Magic-eye" tuning—4 wavebands ranging from 13.5-2,000 metres, 6 Tuned Circuits, Tone Control, Remote Speaker Switch, 4.5 watts Audio Output.

In every respect this set is equivalent to one costing 12 guineas or more and incorporates every worthwhile development in modern radio technique

PRICE 10 GNS.

Get your news early from abroad and your music perfectly.

VIDOR ALL - WAVE BATTERY SUPERHET.

Model 322. This set will receive the whole World's programmes, America, Australia, Japan, as well as all the Home and Continental stations at full entertainment strength and with Quality not yet surpassed in a Table Model Receiver.

Brief Specification : 4 Wavebands 16-2,000 metres, 6 Tuned Circuits on all bands, 4 Valves, including Push-Pull Output Pentode (1 watt), Scale illuminated at will, Tone Control, Switches for local-distance and for Internal or Remote speaker.

Price (excluding Batteries) **9 GNS.**

Exactly similar in appearance to Mains Model illustrated above.

VIDOR ALL-DRY BATTERY PORTABLE.

Model 320. Here is the *Ideal Portable*. Always ready at any time or place. For A.R.P. shelters or Posts (gloomy but necessary thought) at home (upstairs or down) in the car (petrol permitting). Capable of bringing in all Home and Continental programmes on medium and long wavelengths wherever it is used.

Specification : 4 Valves—All-Dry Batteries—2 Wavebands, 200-550 and 1,000-2,000 metres. Circuit T.R.F. receiver with four 1.4 volt dry battery valves, Pentode H.F. stage, detector with reaction, triode L.F. and Pentode output feeding into a sensitive moving coil speaker. Automatic bias—Three controls : on-and-off and wave-change switch, tuning control and reaction control. A Turntable is fitted. Price (complete with Batteries)...

7 GNS.

COMPARE VIDOR RECEIVERS WITH ANY OTHER ON THE MARKET. ASK YOUR DEALER FOR A DEMONSTRATION, YOU WILL THEN APPRECIATE THE ECONOMY AND SUPERIORITY OF VIDOR.

If your dealer is temporarily out of stock write direct to us giving his name and address.

VIDOR LIMITED, WEST STREET, ERITH, KENT.

'Phone : Erith 3080.

Mention of "The Wireless World," when writing to advertisers, will ensure prompt attention.

Proprietors : ILIFFE & SONS LTD.

Editor :
HUGH S. POCOCK.

Editorial,
Advertising and Publishing Offices :
DORSET HOUSE, STAMFORD STREET,
LONDON, S.E.1.

Telephone : Waterloo 3333 (50 lines).
Telegrams : "Ethaworld, Sedist, London."

COVENTRY : 8-10, Corporation Street.
Telegrams : "Autocar, Coventry." Telephone : 5210 Coventry.

BIRMINGHAM :
Guildhall Buildings, Navigation Street, 2.
Telegrams : "Autopress, Birmingham." Telephone : 2971 Midland (5 lines).

MANCHESTER : 260, Deansgate, 3.
Telegrams : "Iliffe, Manchester." Telephone : Blackfriars 4412 (4 lines).

GLASGOW : 26B, Renfield Street, C.2.
Telegrams : "Iliffe, Glasgow." Telephone : Central 4857.

PUBLISHED MONTHLY.
Price : One Shilling
(Publication date 20th of each month.)

Subscription Rates :
Home and Abroad, 14/- per annum.

As many of the circuits and apparatus described in these pages are covered by patents, readers are advised, before making use of them, to satisfy themselves that they would not be infringing patents.

No. 1049

VOL. XLVI No. 1

NOVEMBER 1939

Contents

EDITORIAL COMMENT	1
GRAMOPHONE RECORD SCRATCH. By M. G. Scroggie, B.Sc., A.M.I.E.E.	3
PROBLEM CORNER	7
INSTALLING A NEW RECEIVER. By W. H. Cazaly	8
CHARACTERISTIC IMPEDANCE—AND ALL THAT. By "Cathode Ray"	10
SHORT-WAVE RECEPTION. By "Ethacomber"	12
MORSE AND HOW TO LEARN IT	13
TEST REPORT : PYE "INTERNATIONAL" Model 906	16
BATTERY SW CONVERTER	19
CURRENT TOPICS	20
UNBIASED. By Free Grid	23
DIRECTIONAL RECEPTION. By C. R. Leutz	25
LETTERS TO THE EDITOR	27
VALVE-OPERATED SMOOTHING CIRCUIT	28
TEST REPORT : PILOT "TWIN MIRACLE" PORTABLE	30
RANDOM RADIATIONS. By "Diallist"	33
SHORT-WAVE STATIONS OF THE WORLD	36
RECENT INVENTIONS	37

LISTEN TO THE WORLD'S WAR NEWS

... on the SHORT-WAVES—with a TROPHY



Wave-range 6.5 to 545 metres

Immediate delivery.
ORDER NOW FROM

PETO SCOTT CO. LTD.,

77 (WWM) City Road, London, E.C.1. Tel.: Chisold 9875.
41 High Holborn, W.C.1. Tel.: Holborn 3248.

The Short Waves have so much English and uncensored more than ever before.

TROPHY 6. A.C. 6-valve superbet junior communications model. Wave-range 6.5 to 545 metres for all-world short-wave contact and for B.B.C. Home Service reception. Electrical handspread tuning. Switched A.V.C. and B.F.O. Built-in moving-coil speaker. Socket for alternate 'phone use. For use with ordinary or doublet-type aerial. Ready for operation on A.C. 200/250 v. Fully guaranteed. Price **£10 : 19 : 6**

PLEASE SEND FOR FREE technical specifications. Easy payment terms available on all TROPHY receivers.

to offer you these days... All-World War news and opinions—in Entertaining programme, too. You need a TROPHY now.

TROPHY 8. Super 8-valve A.C. communications model. B.F. on all bands. Wave-range 7 to 550 metres. Handspread tuning. A.V.C. and B.F.O. switches. Designed for use with separate high-impedance P.M. speaker. Provision for 'phones. Housed complete in cabinet with all smoothing equipment. Ready for immediate use. Price **£13 : 17 : 3**

Matched Cabinet Speaker (recommended also for general use), £2 : 6 : 3 extra.

New 2-Stage PRESELECTOR. Recommended R.F. Amplifier for your present all-wave receiver. Provides increased range, selectivity, signal strength and reduction to a minimum of 2nd-channel interference. Wave-range 7 to 550 metres. Spread tuning. For use with any type of set. Built-in power-pack. Peasing cabinet. For A.C. 200/250 v. Fully guaranteed. Price **£7 : 8 : 6**

TROPHY 3. Regenerative 3-valve battery and A.C. models available at remarkably low costs. Wave-range 6.2 to 550 metres, using self-locating coils. Metre and hand-calibrated scale. Built-in moving-coil speaker. Jack for 'phone use. Fully guaranteed and supplied with coils for 12-52 metres.

A.C. Model £8 : 18 : 9
Battery Model (less batteries) **£6 : 6 : 6**

For extra coils for complete coverage 6.2 to 550 metres, add 18/6 to above prices.

WEST END LONDON demonstrations—call at R. E. M. LTD., 70, Wigmore St.

Good Luck!



*F*or 28 years now "The Wireless World" has been serving the whole wireless industry—and in particular that group of knowledgeable and enthusiastic amateurs of radio to whom so much of the present success of the industry is due. Radio, to-day, makes its appeal to millions, but I have often thought and said that too little attention is paid to that numerically small group who are still technically interested in radio engineering and who keep abreast of its development. Every wireless engineer, professional or amateur, will be glad that "The Wireless World" has decided to continue publication in spite of great difficulties. It deserves support from all of us and I hope it gets it.

E. J. POWER,
Managing Director.

MURPHY RADIO

MURPHY RADIO LTD., WELWYN GARDEN CITY.

Mention of "The Wireless World," when writing to advertisers, will ensure prompt attention.

The Wireless World

COVERING EVERY
WIRELESS INTEREST

ESTABLISHED
1911

No. 1049. Vol. XLVI. No. 1

NOVEMBER 1939

Price One Shilling

Editorial Comment

Listening in Wartime

IN recent issues we have surveyed editorially the effects of the war on wireless in its various aspects—communications, broadcasting and with regard to the manning of the various services. Finally, we discussed our own position, explaining why it had become necessary for us to revert to monthly publication “for the duration.” The friendly spirit of co-operation in which our readers have accepted this change, and promised their continued support, will be referred to later.

The time seems appropriate for considering the repercussions of the war on the broadcast listener, and for offering some suggestions as to how he can make the best of prevailing conditions. Of all listeners, those music-lovers whose interest lies primarily in high-quality reproduction are probably the most enthusiastic, and it is particularly hard luck that they should have suffered most. “Quality” was the first wireless casualty of the war; the present method of transmitting the single-programme Home Service of the B.B.C., devised to avoid the danger of giving navigational aid to enemy aircraft, certainly fails to give reproduction of pre-war standards to the majority of listeners. There is some possibility that this will be only a temporary phase, but in the meanwhile the type of listener whom we are considering is turning to gramophone music. He will read with particular interest an article in this issue which deals with the reduction of record scratch—the principal remaining obstacle in the way of aesthetic enjoyment of reproduced music.

Though high-quality reproduction may have suffered a temporary eclipse, long-distance short-wave listening has come into its own, both among the general public and in more technically informed circles. “What America said last night” has

become a normal topic of conversation with the man in the train, while technical wireless people, to whom a broadcast was merely “a signal” in normal times, have turned eagerly to the short waves for up-to-the-minute news and diversity of comment and world opinion on current events.

To meet this sudden change in the centre of interest in broadcasting, *The Wireless World* has been reviewing a number of receivers in which special pains have been taken to ensure good performance on short waves. In choosing a set for long-distance news-gathering one must look beyond such obviously desirable features as selectivity, sensitivity and low noise level. For regular short-wave work, easy tuning, definite recording of station settings and freedom from frequency drift are essentials; without these features, searching for the wanted transmission becomes anything but a pleasure; worse still, one is likely to miss the opening sentences of a bulletin.

Improving Reception

As broadcasting is now so much more important than ever before, the listener is better repaid for any pains he may take to ensure reception at its best. The design of the set itself is, of course, a vital matter, but its installation should have more consideration than it ordinarily receives. A contributor, writing elsewhere in the present issue on this latter subject, is not guilty of exaggeration when he says that an apparently trifling improvement to the aerial system may sometimes turn a distant transmission from a mere noise into an enjoyable programme.

Apart from the aerial, something may often be done to improve signal-noise ratio by fitting anti-

Editorial Comment—

interference devices at the listener's end. A simple condenser filter at the point where the electric mains enter the building is often effective, though a more favoured remedy nowadays is the fitting of a "set lead filter," generally comprising both inductance and capacity, at the mains outlet from which the receiver is fed. In difficult circumstances a proper anti-interference aerial is a refinement to be recommended.

Finally, there is the question of comfort and convenience in listening, which under wartime conditions assumes greater importance than in normal times. One or two suitably-disposed extension speakers can make a world of difference in this respect.

Hitler's Rise to Power

Black Mark Against Wireless

IN 1936 *The Wireless World* completed its 25th year of publication, and to celebrate the event we issued a special number, including what we described as a "Cavalcade of Wireless" in which the developments of the past quarter-century, as unfolded in our pages, were reviewed.

It would have been pleasing to close that survey on a cheerful note, but it happened that the time it appeared coincided with the consolidation of Hitler's power in Germany, and it seemed to most thinking people that the particular aggressive brand of Nationalism run riot that has since been branded as Hitlerism was likely to lead to war.

Commenting on the events of the preceding year (1935) with the restraint that was then considered proper, we said "Almost up to this time we wireless people had always been encouraged in our work by the comforting thought that the new means of communication was entirely beneficial to humanity, although some recent events had given rise to disturbing thoughts." On the same page we reproduced a photograph of factory workers listening to a swastika-decorated loud speaker.

Continuing on the same theme, we referred to the use of broadcasting as an instrument of propaganda, and said "Without enquiring into the rights and wrongs of the aims propagated, it is certain that the historian of our generation will have much to say on the successful exploitation of mob psychology by wireless and the speech amplifier."

We had then formed the opinion that Hitler's rise to power was largely due to his successfully applied technique of stimulating a kind of mass hysteria among enormous audiences with the help of PA gear, and this view was largely supported—but with bated breath—by German wireless men.

Thus it would seem that wireless—or at any rate wireless technique—has gained a black mark. But, if wireless put Hitler in, it will assuredly play an important part in getting him out. As we said in concluding our quarter-century review, "We can take courage for the future in the thought that the technical developments in which we have played our humble part can certainly be used as readily for propagating good as for evil."

Thanks to Our Readers

—And a Request

WE should like to offer a sincere word of thanks to those of our readers—and they are many—who have written to us during the past week or two in connection with our decision to become a monthly publication during the war. Both the number and the tone of the letters are extremely gratifying to us.

And now, at the risk of our being regarded as justifying the old saying that gratitude is merely a lively anticipation of favours to come, we are going to ask our readers to do something for us. Before doing so, however, we should like to offer a word of explanation concerning the manner in which *The Wireless World*, in common with other periodicals, is distributed to the various newsagents.

In normal times newsagents are supplied with far more copies of a journal than are necessary to fulfil the orders of their regular customers. This is done in order to cover casual sales, which, in the case of a railway station bookstall, for instance, form the bulk of the total number of copies sold. Under this system, any copies remaining unsold are returned to the publishers, and the newsagent is duly credited with their value.

After to-day, however, it will no longer be possible for newsagents to return unsold copies. The reason is that all publishers desire to comply loyally with the Government's request for economy in the use of paper. In order to achieve this very necessary national economy, the publishers of *The Wireless World* have decided, in common with the publishers of other journals, to print only as many copies as are sufficient to fulfil definite orders.

It will be clear from the foregoing explanation that we must very earnestly request readers to place a definite order for *The Wireless World* with their newsagent by filling in the order form enclosed in this issue. This form should be handed in as soon as possible. It should be pointed out that an order so given does not commit the reader to any long-term obligation, as it can be cancelled at any time. Those readers who prefer to do so may of course subscribe direct to this office.

Gramophone Record Scratch

MINIMISING SURFACE NOISE IN REPRODUCTION

By M. G. SCROGGIE, B.Sc., A.M.I.E.E.

COMPARED with broadcast programmes, gramophone records have the great advantage of giving what you want when you want it. On the other hand, they cost much more, they require a certain amount of manipulation in order to play them, and they interrupt long items at least once every four and a half minutes. As regards background noise, records score over radio in unfavourable situations, but are inferior to radio in good situations. Certain background noises—motor rumble, amplifier hum, and pick-up buzz—can be practically eliminated by proper design of those items in the equipment; but, when all has been done that can be done at the listening end, there is still record surface noise, or so-called "scratch." The quality enthusiast finds to his sorrow that if he extends the frequency range of his apparatus by using a high-quality pick-up, amplifier, and loud speaker, the scratch becomes so pronounced as to rob him of the reward of his efforts. Although the record-makers have improved their products in many ways, they seem to make comparatively little progress in background reduction, especially compared with recent sound-on-film developments.

Part of the noise is in the original sound; that is to say, it would be heard on a loud speaker connected in place of the recording head. And part is due to the various processes of manufacture. For example, the original wax master is dusted with metal or graphite powder to form a conducting surface for electro-plating, and a certain amount of surface irregularity may be due to this. Faulty treatment in the pressing is another cause. In good records all the foregoing sources of noise ought to be relatively small. What is heard is then due mainly to the material of which the record is composed. At one time abrasive material was actually intentionally included in the mixture with the object of quickly grinding the playing needle point to the contour of the groove. The choice of materials now is determined chiefly by a balance between economy and physical properties such as hardness, durability, uniformity, and so forth. A typical formula for a solid-stock compound is:—

Slate dust	56	per cent.
Orange lac	22	per cent.
T.N. shellac	16	per cent.
Rosin	4	per cent.
Lamp black	1.5	per cent.
Cotton flock	0.5	per cent.

From this it can be seen that the loading material, slate dust, is more than half the total mixture; and, however finely it is ground, it is, nevertheless, in the form of separate hard particles embedded in the binding materials. Although the record surface looks beautifully smooth, from a microscopic point of view it is granular. The needle is therefore affected not only by the "waggles" of the recorded programme, but also is continually hitting the irregularities of the surface, which is therefore heard as "scratch."

WARTIME broadcasting does not always permit reproduction of a standard that satisfies the critical listener. Gramophone music therefore takes on a new interest; this article deals with means of reducing surface noise, which remains the principal obstacle to the enjoyment of recorded music.

One sometimes comes across references to "fitting a filter to cut out the scratch frequency." Indirectly, that has a certain meaning (which will be dealt with later), but if the idea in mind is that scratch is confined to a certain band of frequency or occurs only above a certain frequency it is quite erroneous. The granular structure of the record surface is not regular, like the blocks in a paved road; but is completely random, more like the irregular bumps of a rough gravelly road. So the sound produced has no definite frequency, being, in fact, very much like the "shot" or thermal fluctuation noises that are heard from a receiver with excessive amplification.

A number of years ago Buchmann and Meyer analysed scratch into its spectrum, obtaining the curves (from *E.N.T.*, May, 1931) reproduced here to a decibel scale as Fig. 1. The disc tested was one on which no sound had been recorded; and separate curves are given for grooves on outside, middle, and inside sections of it. The reduction in upper frequency sound as the needle progresses to the innermost grooves is confirmed in practice: the change-over from one disc to another in broadcasts of long recorded items is very skilfully done by the B.B.C., but the sudden rise in scratch usually betrays it to the attentive listener.

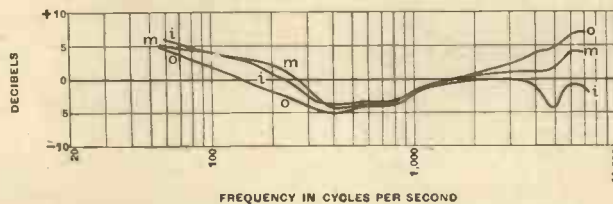

Fig. 1.—Buchmann and Meyer's frequency-analysis of record surface noise. Tests made on outer, middle, and inner grooves are distinguished by o, m, and i respectively. The decibel zero is arbitrary.

The most important feature of the curves, however, is that they extend fairly uniformly (apart from a hollow around 400-800 c/s) over the whole audible frequency band, and that the noise is at least as strong at very low frequencies as very high.

Before coming across these curves, the writer had carried out on more recent records some tests of his own, made possible by the courtesy of Messrs. Claude Lyons, Ltd., who kindly lent one of the new Model 736-A General Radio Co.'s Wave Analysers. This instrument is in effect a calibrated audio-frequency superheterodyne receiver, with an IF response only 4 cycles

Gramophone Record Scratch—

per second wide. By varying the oscillator tuning the whole audio-frequency band can be explored, and the response on the meter indicates the intensity at any selected frequency. One of the most useful applications of the instrument is in measuring the percentages of each har-

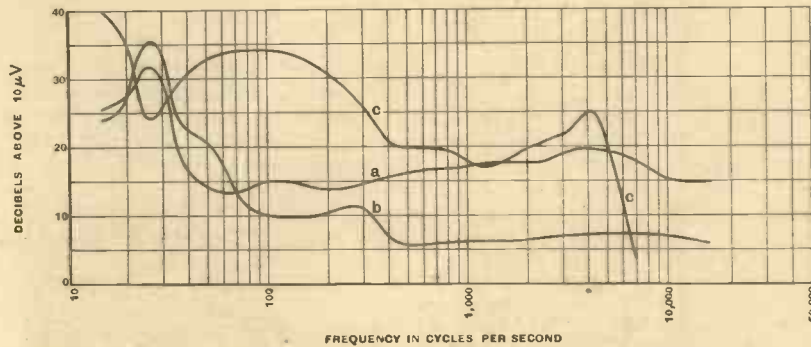

Fig. 2.—Analysis made with a G.R. Wave Analyzer. For curves (a) and (b) a Telefunken pick-up was used : (a) was an old and scratchy record ; (b) a recent and slightly-used issue. The peak at 27 c/s is probably a characteristic of the pick-up, or rather its carrying-arm. Curve (c) refers to the same record as (b), but with a typical needle-holder pick-up. Although the scratch level is higher, the programme/scratch ratio is not necessarily so, because the pick-up gives a greater voltage output.

monic in a distorted waveform. But it can also be used for showing the frequency distribution of such an irregular phenomenon as "scratch." The instrument is so sensitive that it was possible to get adequate readings straight from even an insensitive type of gramophone pick-up. The Telefunken pick-up was used, because its response is very nearly uniform over the whole range of frequency, so there is no need to make special corrections for its characteristic. No unmodulated discs were available, so use was made of a few records that happened to have more grooves than usual between the end of the music and the run-off. The eccentric motor-stopping groove itself, though it would have been convenient for the test owing to its endlessness, has rather different characteristics from the plain-cut (recordable) groove.

Structure of Record Blanks

On this irregular sort of "signal" the meter fluctuates rather considerably, so it is not a case for extremely precise results, and the curves (a) and (b) in Fig. 2 must be judged accordingly. They refer to two different records. The intensity is expressed in decibels above 10 microvolts at the terminals of the pick-up. Although the general shapes differ a good deal from those of Buchmann and Meyer's curves, they agree in covering the whole frequency scale and also in rising at the low-frequency end.

It is clear, therefore, that the conception of scratch being distinctly separable in frequency from the recorded programme is fallacious. But on the other hand it must not be concluded that nothing at all can be done about it.

There are difficulties in eliminating surface noise at the record manufacturing end, but let us hope that they are not permanent ones. Amateur recordists and others using direct play-back discs know that when these blanks are correctly cut the scratch is practically non-existent for a considerable number of playings. This is because the material is homogeneous instead of granular, and also because several intermediate processes in the preparation of quantity-produced records are skipped.

If the record manufacturers were to give us quiet back-

ground records (pressings in vinyl resins or in cellulose-acetate or a synthetic resin instead of the ordinary solid-stock, might be a solution), there would be no need to worry about the problem any more. As it is, we must make the best of what we have. Normally it may be accepted that the harder and more glossy the surface of records the better, so one way of keeping them in the best condition is to use a polish, which may be composed of equal parts of raw linseed oil, turpentine and white vinegar. But it should be used sparingly and the records kept under cover, as the dust attracted may make matters worse. Something can be done, too, by careful adjustment of the pick-up needle and carrying-arm angles and attention to the tracking alignment.

Coming now to consider the frequency characteristic of the whole reproducing apparatus, the top limit of recorded frequency is generally accepted as being somewhere between 6,000 and 8,000 c/s. But Fig. 2 shows that scratch extends much higher, assuming the ability of the pick-up to follow such rapid movements and of the apparatus in general to reproduce them. If "noise" is distributed uniformly over a frequency band, its total power is proportional to the width of that band. So it is obvious that the first thing to do is to lop off anything beyond the useful range of frequency ; that is to say, anything above 8,000 c/s. The Telefunken pick-up, in conjunction with a wide-range amplifier and loud speaker, gives an intolerably large amount of scratch,

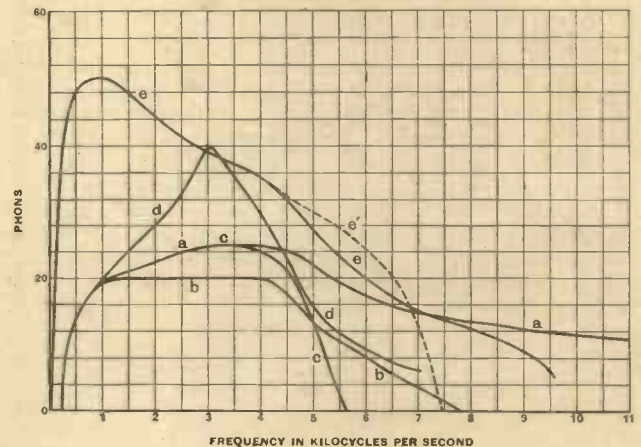

Fig. 3.—Noise distributed uniformly over the frequency scale at a level of 20 db. would have the loudness/frequency characteristic shown by curve (a). If modified by the characteristics given in Fig. 4 the results are as shown by (b) and (c). The reduction in area below curve (a) gives an impression of the reduction in audibility. Modified by a certain bad old model of pick-up the result is given by (d). Curve (e) indicates a typical programme spectrum.

which can be substantially reduced by cutting off above the limit of recording.

But when that has been done, scratch is still too prominent. Now, although it is difficult to get authentic information about the characteristics of records, some

Gramophone Record Scratch—makes at least appear to give a slight lift—about 4 db—towards the upper end of the band, say, between 4,000 and 6,000 c/s. It is therefore allowable to reduce the response at the reproducing end by about this amount, giving a corresponding reduction in scratch without any departure from strictly level response to the programme.

If the recordists were to extend this practice, boosting the top frequencies by a really substantial amount, scratch in this part of the scale could be reduced to negligible proportions without sacrificing quality. Apparently it is not technically practicable to record on a constant-amplitude basis throughout (as is done at present up to about 250-400 c/s) corresponding to steadily increasing needle velocity

most effectively by reducing the high-note response. The explanation is that the ear is more sensitive to the upper frequencies. It is another example of the important difference between *intensity* and *loudness*. Figs. 1 and 2 show intensity; the effect produced on human beings—loudness—is quite different. To emphasise this, Fig. 3 (a) shows the loudness (expressed in phons) of a sound equally intense over the whole frequency scale at a level of 20 db. above the usual arbitrary zero. As noise energy is proportional to frequency band width, this curve has been plotted on a linear frequency scale instead of the usual logarithmic scale, so that the loudness of the whole may be seen in terms of the area beneath the curve. Nothing below 230 c/s is audible at all, while the greatest audi-

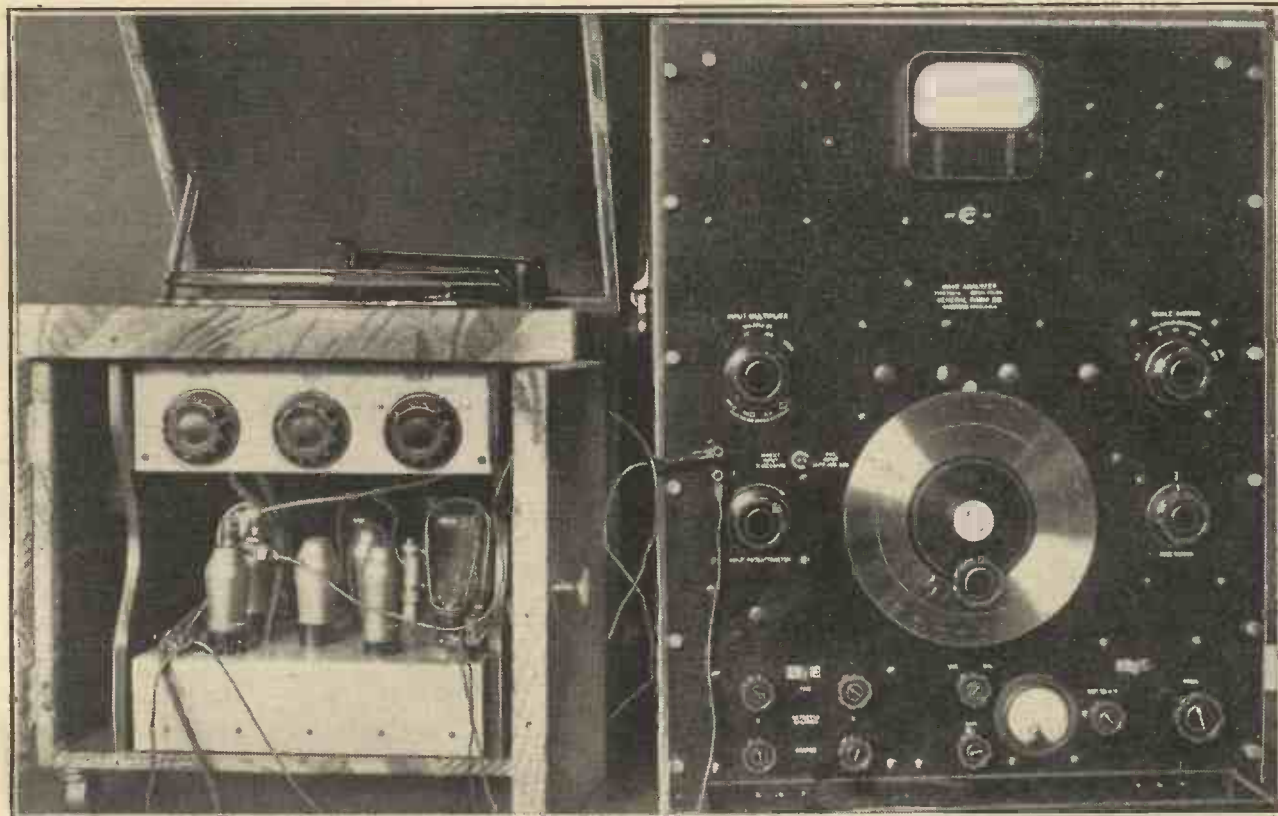

The Wave Analyzer used for obtaining the curves of Fig. 2. The pick-up was connected straight to the input of the analyzer, the gramophone amplifier not being used.

with frequency, because record wear would be excessive. It is not *commercially* practicable to go even part of the way in this direction, because the tone given by uncorrected gramophones would be too shrill.

So far, we have reduced frequencies around 5,000 c/s by a few db., and cut off altogether above 8,000. But scratch is still quite noticeable. What can be done? It may be necessary to make some compromise with quality, bearing in mind that fairly considerable departures can be made from level frequency response without seriously spoiling the reproduction. The question is, how can we effect the greatest reduction in scratch with the least sacrifice of programme when both are mixed up together?

Although the distribution of scratch appears to extend over the whole frequency scale, and to show a rise in the bass, this is not inconsistent with the general impression that it is a high-frequency sound, and can be got rid of

bility is up in the thousands of c/s. It can be understood, therefore, how the low-frequency components of scratch, though actually stronger than any others, may be quite inaudible, whereas the highest frequencies are plainly heard. This state of affairs does not exist so far as very loud sounds are concerned; but, fortunately, scratch is, at worst, much weaker than a normal programme. The phenomenon of acoustic masking also helps in preventing low-frequency scratch from being of any practical importance, and we can forthwith neglect it.

Assuming as a first approximation that scratch is a noise uniformly distributed over the frequency scale, and of low intensity (20 db.), Fig. 3 (a) gives its loudness spectrum. What about the recorded matter? Its spectrum depends, of course, very largely on the programme recorded; but data exist on the probable maximum intensities at different frequencies, taken over a large selection of typical material,

Gramophone Record Scratch—

of broadcast programmes. Fig. 3(e) is based on a curve given by P. P. Eckersley.¹ Presumably an analysis of a large number of typical gramophone records would give similar results, except perhaps a modification approximating to that shown by the dotted line (e'). In order to represent recording at a low-enough level for scratch to be disturbing, the maximum intensity has been taken as low

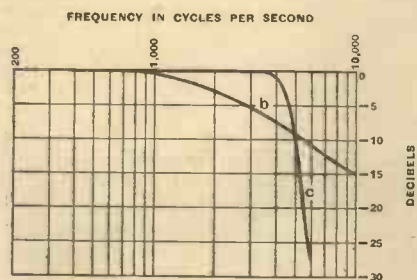

Fig. 4.—Alternative tone control characteristics for reduction of scratch. For the effects, see Fig. 3.

as 50 db., and the phon curve is worked out on that basis. It can be seen that the centre of gravity, so to speak, of the programme (e) is considerably lower in frequency than that of the scratch (a), and, therefore, should be considerably less affected by entirely eliminating

the top frequencies from the reproduction. Assuming curves (a) and (e) in Fig. 3 represent respectively scratch and programme in very quiet parts of a record, and neglecting minor complications such as masking, the ratio of the two can be derived for any top cut-off frequency. This is shown as curve A in Fig. 6. Thus, if all frequencies above 9,000 c/s are removed, the programme is only 50 per cent. louder than the scratch; if the cut-off is brought down to 4,500 c/s it is 100 per cent. louder; and so on. As the cut-off frequency is brought very low, the improvement is rapid; so, as an antidote, curve B is also shown. It is based on data by W. B. Snow² showing the deterioration in quality of reproduction of orchestral music as frequencies above those specified are removed. It is not possible to follow the original data above 7,500 c/s, because such frequencies are not present in the record, and, therefore, no improvement in quality results from a wider range. The best balance between A and B depends on personal preference. It also shifts to a higher frequency as the programme is more loudly recorded, because then A rises much higher.

Practical experience, as well as the foregoing theory, shows that it is most profitable to reduce high-note response in seeking relief from scratch. In describing the electric gramophone in the issue of May 11th, the writer mentioned that, after comparing the general balance of quality and freedom from scratch given by the two types of characteristics contrasted in Fig. 4, he decided in favour of the gradual slope, although to the eye there is little to choose. Plotting on Fig. 3 the effects of these characteristics on the loudness of a uniform input of 20 phons it can be seen that both cut off the useless frequencies above 8,000 c/s and reduce the area of scratch by an approximately equal amount. The gradual reduc-

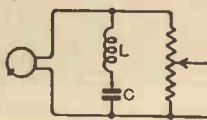

Fig. 5.— Simple scratch filter for use with resonant pick-up. The value of LC depends on the frequency of resonance, but the separate values must be appropriate for the impedance of the pick-up.

tion of the upper musical frequencies, on the other hand, seems for some reason to be more acceptable than the more sudden characteristic. Although a reduced response is suffered over a greater band of frequency, the band over which some response is given is greater. It seems to be an example of half a loaf being better than no bread. Moreover, a muffling of the higher frequencies is quite a common natural effect in certain acoustical situations; but there does not ordinarily occur in nature a sudden cut-off at a particular frequency, and perhaps the ear finds the artificial introduction of such an effect rather disconcerting. It is fortunate that the gradual characteristic is preferred, for it is much more easily obtained than the cut-off.

The shape of a curve, such as Fig. 3(a), of sound assumed to be originally of uniform intensity, is controlled by the characteristics of the listening ear. That accounts for the drop to zero at the low-frequency end, and the rise around 3,000 c/s. But we have seen how it is affected by non-uniform characteristics in the apparatus (e.g., tone control). The Telefunken pick-up is not typical in this respect; for, as Fig. 2 shows, its response continues up to 16,000 c/s, and there are no signs of marked resonances (except at the low-frequency end, where the rise is probably due to carrying-arm resonance). The usual type

of pick-up with needle holder is quite different, for it is very difficult to keep its armature resonance from coming well into the useful range of frequency. In Fig. 2 curves (c) and (b) are from the same record, but using an average commercial pick-up—neither very good nor very bad. To the extent that the scratch input is uniform, this curve represents the characteristic of the pick-up. Elimination of the scratch above 8,000 c/s is seen to be accomplished by the pick-up itself; so when used with otherwise "level" apparatus it would give a lower proportion of scratch than the Telefunken. Remembering that if anything the programme frequencies around 5,000 c/s are above normal, it is clear that a reduction at this point of about 10db in the amplifier can be used to advantage to counteract the plainly visible pick-up resonance, with a very noticeable reduction in audible scratch.

The Use of Filters

Some pick-ups have a far more pronounced resonance; so much so that if the audibility curve were plotted on Fig. 3 it would not be far wrong to say that the scratch has a definite frequency. Listening to it, the sound is not purely irregular, like the noise of escaping steam, but is more like a whistle of recognisable pitch. This is, of course, not really the mythical "scratch frequency," but the resonant frequency of the pick-up. When the designers of the pick-up are clever enough to get this resonance as high as 7,000 or 8,000 c/s, scratch can be very effectively dealt with by employing a filter tuned to that frequency (Fig. 5). The product LC is calculated from that frequency, but the

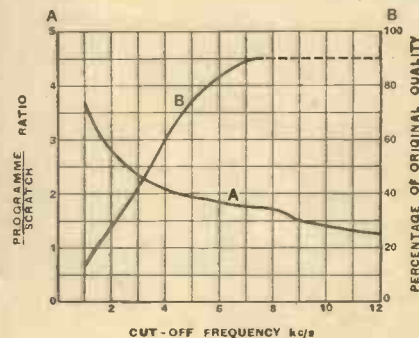

Fig. 6.—Curve A shows the improvement in programme/scratch ratio, and curve B the deterioration in programme quality, under the conditions specified in the article, as the top cut-off frequency is reduced.

¹ "A Quantitative Study of Asymmetric-Sideband Broadcasting," *Journal I.E.E. (Wireless Section)*, Sept. 1938, p. 148, Fig. 14.

² *J. Acoust. Soc. Amer.*, July, 1931.

Gramophone Record Scratch—

values of L and C depend on the impedance of the pick-up. But if the resonance is in the essential frequency range it boosts the scratch into a penetrating whistle (incidentally much less likely to be covered by acoustic masking) and nothing can be done about it short of hopelessly degrading the quality. Fig. 3(d) is an example of this; it is the audible result of uniform 20-db scratch reproduced by a pick-up made by a firm famous for high-quality reproduction and sold at an exorbitant price in 1930. A very nasty piece of work.

So far we have tried to weed the scratch out from the recorded matter by frequency discrimination. Unless the quality of reproduction is seriously impaired, however, the scratch frequencies in the band 500-4,000 c/s are enough to render it audible, at least during the quieter parts of the programme. Another way of tackling the problem is amplitude discrimination. By using contrast expansion, the passages that are loud enough to mask the scratch completely are made louder, and the soft music where scratch is normally heard are made softer. During the times when scratch is most obvious—when no programme sound at all is being uttered—the amplification can be reduced enough to suppress it altogether.

Summary of Conclusions

Such equipment has to be very carefully designed, or it introduces greater evils than it sets out to cure—amplitude distortion, for example. It can, however, be very effective. The main object is to increase the lifelikeness of the reproduction by restoring the large range of contrast in certain musical performances. To do this successfully demands a very large reserve of undistorted sound output, which is costly; but it is just a thought that, if noise reduction only is aimed at, a much simpler arrangement might be devised that would suppress scratch during the moments when no other sound is being heard. A very moderate and judicious use of muting, in fact. Looking at Fig. 6 suggests another, but rather more complicated, idea—a device for reducing the top frequencies at low-programme amplitudes.

Recapitulating: "Scratch" is due mainly to the material of which commercial discs are at present manufactured, but may be aggravated by inferior recording and processing, and embraces all frequencies. It can be minimised, first, by care of the record itself and proper adjustment of the pick-up and arm. As recorded frequencies do not exceed 8,000 c/s, any response above this should be eliminated, and the pick-up should be such that any pronounced resonance comes within the excluded frequencies. It is allowable to reduce the response by a few db. in the 4,000-7,000 c/s region, and with many records considerably more top-note reduction may be expedient. To obtain the best compromise between quiet background and good quality an adjustable tone control is very desirable, giving various degrees of gradual reduction, and in any case cutting off above 8,000 c/s if the pick-up does not do so. If the pick-up does show a pronounced resonance at a lower frequency, a suitable filter tuned to it improves both quality and quietness. Although the lowest scratch frequencies are inaudible and the highest can be eliminated, the intermediate band coincides with the desired programme sounds. It is drowned by them when they are loud, and can be reduced during quiet passages or intervals by automatic reduction of amplification, as in contrast expansion systems.

The writer is indebted to Mr. D. W. Aldous for information on record-manufacturing technique.

Henry Farrad's Problem Corner

No. 40.—Capricious Geese

An extract from Henry Farrad's correspondence, published to give readers an opportunity of testing their own powers of deduction:—

Glenechty Lodge,
Skye.

My Dear Henry,

I forget whether I told you that we got a wireless a few months ago—in June, I think it was. We felt so shut off in the Isles, with all these wars and rumours of wars going on. They wanted to sell us an expensive one—a "super hot" or something—but we got this little one, and it serves very well for our purpose, which is to hear the news after your Uncle gets in at night.

But the last few weeks it hasn't been nearly so clear; it seems as if the noise of the war was getting in! I had a man over to see it one forenoon, and a rare fool I looked, because it was just the same as it used to be, nothing wrong with it. But sure enough, when Will came in, it was just like a flock of spitting geese.

It's not very serious because we can follow the news fairly well, so don't let it bother you, but if you can tell what sort of a thing it would be it would be interesting to know.

Your Affectionate,
Aunt Grace.

Have you any theory? Think it over, and then turn to page 9 for Henry Farrad's explanation.

Cellulose Spraying

THE amateur who builds his own chassis and the serviceman who may be called upon to renovate an old receiver will be interested in the "Kwik-Spray" equipment marketed by the Cooper Perry Manufacturing Co., Ltd., 26, Charlotte Street, London, W.1, and costing 15s. 6d.

To achieve a professional finish with cellulose paint a steady air pressure is essential, and in this case the spare tyre of a motor car is used as the source of supply. The spray gun consists of a glass reservoir for the paint, and is fitted with the usual jets for the liquid and air streams. A finger-operated valve regulates the air supply, and if used dry the gun provides a convenient means of blowing dust from awkward corners of a receiver chassis.

The dealer will find other useful applications for this apparatus including sign writing with the aid of stencils.



Installing a New Receiver

IMPORTANCE OF THE AERIAL-EARTH SYSTEM

By W. H. CAZALY, Grad.I.W.T.

TO obtain the full benefit of a good modern broadcast receiver, the makers' instructions are sufficient only up to a point. They cannot take into account individual conditions, and the conscientious set owner should take matters up where the makers leave off. This is applicable not merely to the problem of receiving very distant transmissions, but to the reception of local and powerful foreign broadcasts unmarred by mush. In short-wave reception, indeed, it is hardly too much to say that the aerial-earth system is quite as important a factor as the design of the set.

In the first place, the position of the receiver in respect to the aerial deserves more consideration than (largely, it must be confessed, owing to the æsthetic postulations of the feminine elements in households!) it usually gets. If the lead from the aerial to the receiver must pass through the whole house from front to back or vice versa, it will nullify all the care expended in the erection of a good external aerial, because this part of the system picks up more interference than the rest together. After all, there are extension-speaker fittings, and they are preferable to expensive screening or anti-interference devices.

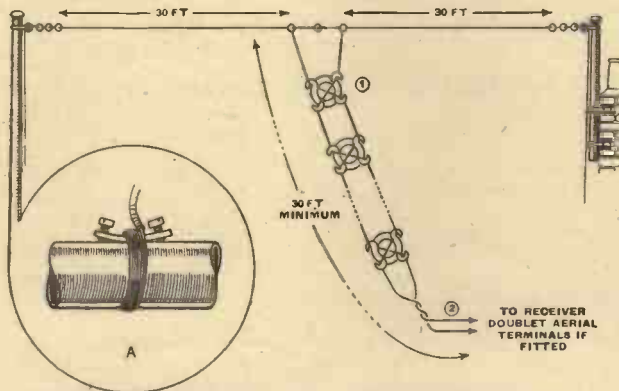

Doublet aerial for short waves. The transposition blocks (1) through which the feeder wires are crossed should be spaced 18 in. The aerial becomes an ordinary "T" if the leads of the feeder (2) are twisted together and connected to the aerial terminals. Inset A shows a simple earthing connection.

For general purposes, only the inverted L and the doublet types of aerial need be considered. There are innumerable other systems, but these are largely monopolised by advanced workers; they will make no appreciable difference to ordinary broadcast reception. The L type is perfectly satisfactory on all wave-lengths save those of television, unless the zone of local interference is troublesome, when recourse must be had to one of the several commercial anti-interference systems available, about which the makers will give all details and much help in particular cases. The doublet type

is specially suited for short-wave reception, but is perfectly satisfactory also for the medium and long-wave bands if the ends of its transposed feeders are joined and it is used as a plain T type. The transposed feeder

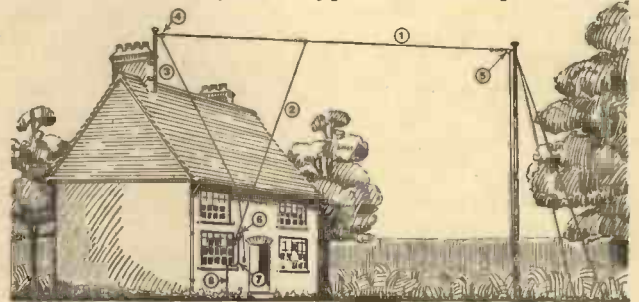

A good "L" aerial. (1) horizontal wire, at least 30 ft. long; (2) down-lead 20-30 ft., kept well away from house; (3) short pole on chimney is recommended; (4, 5) pulleys; (6) cowl insulator; (7) lead-in wire, of workshop cable or screened low-loss cable; (8) thick earth cable.

avoids interference pick-up on the short waves if the horizontal part is out of the interference zone. But the receiver must be fitted for this type of aerial input.

Advice upon the inverted L type of aerial resolves itself in these days to a miscellany of "Don'ts"! Though this may seem purely negative counsel, it appears still to be painfully necessary, as a glance round suburban back gardens always reveals to the initiated. If it is followed, however, the inverted L aerial can be made a very efficient installation indeed. So here are some Don'ts for aerial builders:—

Don't bother too much about enamelled, stranded aerial wire. Plain hard-drawn copper wire from the ironmonger is cheaper and just as good.

Don't economise on insulators: they are more important than the wire. Proper moulded

Courtesy
A. F. Bulgin & Co.
Cowl insulator for anchoring the down-lead, and moulded transposition blocks for the feeder of a short-wave aerial.



Wireless World

Installing A New Receiver—

cowl insulators with fixing brackets and low-loss lead-in devices, protecting live points from wet and dirt, save many precious microvolts from leaking to earth.

Don't dispense with a pulley at both ends of the aerial. You will certainly want to lower it or tighten it or fit another system at some time or just clean the insulators.

Don't take the house end to the eaves. A pole on the chimney turns many foreign transmissions from mere noises into enjoyable programmes.

Don't run the aerial, especially the vertical portion, within 10 feet of any conducting materials such as pipes and wiring (inside as well as outside the house), iron roofs, fencing wire, etc. And don't forget that in wet weather all outdoor surfaces become conductors.

Don't make the aerial plus lead-in (for the L type only: for the doublet, the *transposed feeder* must be longer than $\frac{1}{4}$ wavelength) too long. An L aerial tunes to a wave twice as long as itself. Hence about 25 yards gives good all-round reception on the interesting short-wave bands and is perfectly satisfactory on the usual broadcast bands. Each half of the horizontal portion of a doublet should be about 10 yards for similar results—and each half equally clear of earthed conductors, in order to balance the halves electrically.

Don't make the earth lead a foot longer than is necessary. It all picks up interference and neutralises signals.

Don't earth to a hot-water pipe. It gets to earth after a wander to the top of the house and down again. Use a cold-water rising main.

Don't put up a first-class aerial and then put up with man-made local interference. You will be doing all radio users a good turn by making a firm but polite fuss about it. The Post Office will help you trace its source.

New American CR Tubes

USE OF AN INTENSIFIER ELECTRODE

THE principal improvement to be found in the American CR tube shown in the accompanying photo consists of an intensifier electrode in the form of one or two metallic rings near the screen end of the tube; this serves to accelerate the electrons *after* deflection. It is claimed that the tube gives greatly increased brilliance without corresponding loss in deflection sensitivity. Earlier attempts at increasing deflection sensitivity for a given anode voltage have been along lines of increasing the deflection plate size and decreasing the space between, but there is a definite practical limit in this direction without seriously affecting the focus characteristics of the tube.

The new tube also has several refinements in its gun structure to obtain better focus and modulating characteristics. The electron gun is operated at the same potentials and in the same manner as in other tubes of corresponding screen diameter and the intensifier electrode

may be connected to the final anode and the tube operated in the conventional manner. If, however, an additional voltage equal approximately to the accelerating electrode potential be applied between the intensifier and the second anode, the effect is to brighten the pattern to an extent equivalent to doubling the accelerating voltage, yet not causing so great a sensitivity decrease as would normally result. In terms of screen pattern size, this means that, instead of the 50 per cent. reduction which doubled accelerating voltage would normally produce, the voltage with the use of the accelerating element reduces pattern size by only 18 per cent.

The positive potential required between second anode



A gin. tube of the new "intensifier" type (on left) compared with a standard tube of the same size.

and the intensifier electrode may be taken from existing cathode-ray tube power supply systems by addition of a single half-wave rectifier operating from the same transformer winding and connected in reverse polarity. Filter requirements may be satisfied by the use of a small condenser and a high-resistance bleeder of approximately 10 megohms because of the low current to this electrode.

Henry Farrad's Solution

(See page 7)

AT midsummer, when the set was first used, there is virtually no darkness in the north of Scotland, so reception would have been in daylight, however late the news bulletin. But recently darkness would have been setting in. It is significant that although evening reception has been unsatisfactory throughout recent weeks, the one occasion when it was used in the morning it was all right. From the information given it seems that the receiver is of a cheap "straight" variety, and therefore likely to be deficient in selectivity, especially if closely coupled enough to give good daylight reception from a B.B.C. station on the mainland. This would not matter in daylight, but at night the field strength of more distant adjacent-channel stations would rise enough to give sideband interference with its "spitting" sounds.

If the above is the correct explanation, it is possible that careful adjustment of reaction and volume control will give some relief.

Characteristic Impedance

By "CATHODE RAY"

— AND ALL THAT

Concluded from page 300 of our September 28th issue

LAST month we saw why, when and how the impedances of a generator and its load ought to be matched. An aerial, because it has a radio-frequency voltage set up in it, is a sort of generator; and the receiver to which it is connected is the load. The object is to connect the two so as to deliver as much power as possible to the receiver terminals.

Without bothering just yet about exactly what it means, suppose that the resistance of the aerial is 250 ohms. The dynamic resistance of the first tuned circuit in the receiver—that is to say the comparatively large resistance to which a tuned circuit is equivalent at the resonant frequency—may be perhaps 4,000 ohms at very high frequencies. The ratio is $\frac{250}{4,000}$, or 1:16; and so a 1:4 transformer is needed, as we saw last month.

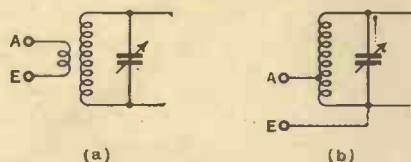

Fig. 4.—Two sorts of impedance-matching transformer for matching a low-impedance aerial or feeder to a high-impedance tuned circuit.

“tapping down” (Fig. 4). At least, it would be easy were it not that for picking up the greatest voltage the aerial should be as high up in the air as possible, especially if it is for television or other short-wave purposes. On the other hand, this is an exceptionally inconvenient spot to install the receiver. Therefore it is desirable to have them in separate places and connect them by a feeder.

Earthed and Unearthed Aerials

If the aerial is of the self-sufficient type (such as the dipole), needing no earth to complete it, there are two connections to be made between it and the two terminals of the receiver tuned circuit. The ordinary elevated wire aerial is just the same, except that the lower half of it is the earth. The latter arrangement, therefore, has its mid-point at ground level, which is generally convenient for a reasonably direct connection to the set, and so the feeder question seldom arises.

Assuming, however, that our aerial is entirely up in the air, and therefore needs a twin connection, how far apart should these leads be? If they are widely spaced, they are, in effect, a single-turn coil of large dimensions and therefore of high inductance. This seems unsuitable for ultra-short wave purposes; and, moreover, is capable of picking up voltages on its own, mostly of an interfering nature. If the wires are very closely spaced, the

capacity between them is large—again a disadvantage, apparently—but at least there is no interference, because the voltages picked up by two wires very close together practically cancel out (one being a “go” wire and the other a “return”). If one wire is entirely surrounded by the other, which is in the form of a tube, it is completely screened. Obviously, owing to the large capacity of the feeder, which acts as a shunt across the input to the receiver, it is of low impedance, and a considerable step-up is needed at that end. The closer they are together the lower the impedance.

Another thing is that at the wavelengths we are considering the feeder is probably at least several times as long as the wave. When, therefore, a signal voltage is picked up by the aerial, it cannot be supposed that it reaches the receiver instantly. By the time it gets there several more waves have been picked up and are en route (Fig. 5 (a)). Suppose that the feeder is disconnected at that end. What are the arriving waves to do? They represent a certain amount of power, which cannot pile up *ad lib.* at the end of the feeder. They do exactly what a sound wave does when it strikes an impenetrable wall—they are reflected or echoed back. If on arriving

SOME DIFFICULT TERMS EXPLAINED

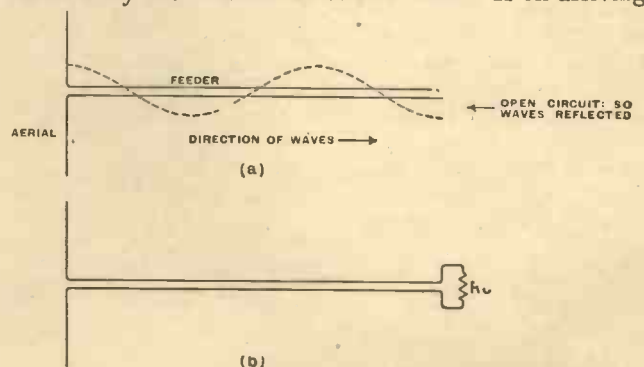

Fig. 5.—A feeder is generally several wavelengths long, and the voltage consequently varies all the way. If the receiver end is open-circuited, the waves have nowhere to go and are reflected. If a resistance is there, generally part of the power is absorbed by it and part reflected; but one particular value of resistance, R_0 , absorbs all the power. Except (a) for a small loss, (b) is then electrically equivalent to (c).

at the aerial again they do not exactly cancel out the latest arrivals, there they are reflected again, and continue surging backwards and forwards until frittered away in the resistance of the wires.

Characteristic Impedance—

Suppose that, instead of being disconnected at one end, the feeder is connected to a resistance. If it is high, the current passed by it when the wave arrives is small, and the power delivered to it is therefore small—less than the waves are bringing. *The surplus* is therefore reflected. There is one particular resistance that uses up power just as fast as it is delivered, and then there is no reflection, no surplus power surging to and fro, and maximum efficiency is reached. The only loss is that due to a single journey through the resistance of the feeder wires, which is comparatively small. This particular resistance is called the *characteristic resistance*; or often the characteristic impedance, but normally it can be regarded as a resistance. Its value depends chiefly on the diameter and spacing of the feeder

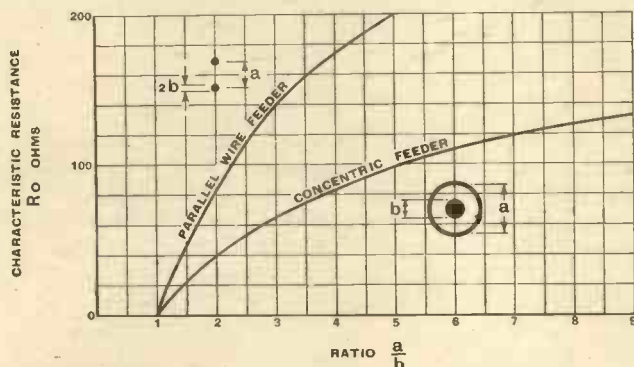

Fig. 6.—Characteristic resistance of twin-wire and concentric feeders.

wires; the smaller the spacing, the lower the impedance. When the feeder is correctly terminated—that is to say, with a resistance equal to the characteristic resistance connected, as in Fig. 5 (b)—then except for the slight loss in the feeder it is the same as if the feeder were abolished and the resistance joined to the aerial.

The two things to know about any grade of feeder are, then, the characteristic resistance and the loss per unit of length (generally given in decibels per 100 feet). You may be wondering where the capacity of the feeder has gone. In a cable of the type used for television it may amount to 1,500 $\mu\mu\text{F}$ in a 100-foot feeder. Knowing that at these high frequencies every $\mu\mu\text{F}$ counts, it seems that it would never do just coolly to ignore such a large amount. But do not let us forget the inductance, even if it is small. The principle of the ordinary tuned circuit is that at any given frequency there is a value of inductance that just neutralises a given capacity. The greater the capacity the smaller the inductance, and *vice versa*. We have already noticed that when a pair of feeder wires are closely spaced their capacity is large and inductance small, and *vice versa*; so it may not come as a great surprise to know that when the spacing is varied these two effects exactly balance one another.

Distributed Capacity and Inductance

When an inductance and a capacity are concentrated or localised, as in the ordinary form of tuned circuit, such a balance holds good at only one frequency. That is the principle on which tuning and selectivity depend.

But when capacity and inductance are distributed along parallel wires, so that different sections of it are at quite different phases (see Fig. 5(a)), the capacity and inductance of the whole feeder is of less significance than those of a section equal, say, to one wavelength. It is as if one had a tuned circuit in which both inductance and capacity are proportional to the wavelength. Now we know that the wavelength at which a circuit is in tune is proportional to \sqrt{LC} . So the interesting result emerges that the inductance and capacity of a feeder cancel out *at all wavelengths*. That is why everything can be ignored except the resistance (it is assumed all the time that the feeder is infinitely long, so that waves starting at one end never return; or that it is terminated somewhere by the characteristic resistance, which amounts to the same thing).

Although the foregoing statements ought, for the reasons given, to be not beyond the belief of anybody familiar with the behaviour of ordinary tuned circuits, their exact truth cannot be proved without some of the riper grades of mathematics, such as I have promised to spare you. It is a matter of interest, however, that if unimportant details are neglected the characteristic resistance is equal

to $\sqrt{\frac{L_0}{C_0}}$ where these quantities are the inductance and capacity per unit length. As formulæ for them are given in any radio or telephony reference book, the characteristic resistance is easily calculated.

What is "Aerial Resistance"?

One point has still to be cleared up. You were asked to take it on trust that the resistance of a certain aerial was 250 ohms. What does this mean? The sort of aeriels we are considering—dipoles, "tilted wires," etc.—differ from the ordinary garden aerial in that they are made of such dimensions as to comprise a complete self-contained tuned circuit resonating at the wavelength

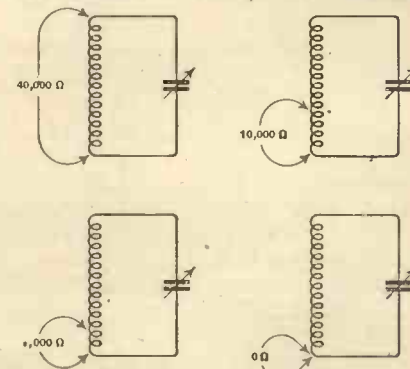

Fig. 7.—Showing how the resistance of a resonant tuned circuit depends on the points between which it is measured. The same applies to resonant aeriels, lines, etc.



Showing the construction of Telcon twin HF cable.

to be received. Although their inductance and capacity are distributed, they are nevertheless true tuned circuits. Now it is well known that a tuned circuit, *at the resonant frequency*, is equivalent to a resistance. The amount of that resistance depends on the points between

Characteristic Impedance—

which it is measured. If across the whole coil (and condenser), the resistance is large. If tapped across part of the coil, or across part of a split condenser, it is less, until it becomes nil when the two points coincide (Fig. 7). The same is true of the resistance of an aerial or other distributed tuned circuit. If points can be found between which the resistance is equal to the characteristic resistance of a suitable feeder, one is in luck, because they can be directly connected. This is so with the ordinary dipole. But when it is not (as in the case that started the whole argument) a matching transformer must be used if losses due to mismatching are to be avoided. Please note now, by comparison with the beginning of the first instalment, that "this is where we came in." I hope that by now the plot is clearer.

One more point. The article quoted goes on to describe the matching transformer used. It is neither the ordinary double-wound nor auto-transformer. It is a carefully measured length of special feeder. By now that ought to cause no surprise, because we have become quite used to the resemblance between localised tuned circuits and distributed ones. If points A, B, X, and Y are selected on a distributed system, such that it has a resistance between points AB of 250 ohms (when a resistance of 70 ohms is connected between points XY) and a resistance of 70 ohms between points XY (when a resistance of 250 ohms is connected between points AB) it can be used as a transformer for matching systems having these diverse resistances; and it may well be more convenient and durable in the open air than the conventional coil-wound transformer.

Short-wave Reception

CONDITIONS IN PROSPECT AND RETROSPECT

CONDITIONS on the short-wave bands, except for a short period early in October, have remained remarkably good during the first five weeks of the war.

In fact, they have been so good that the C.B.S. engineering division felt moved to transfer the daytime WCBX transmissions from 17,830 to 21,570 kc/s (from the 16- to the 13-metre band). Although the new wavelength gives a good signal if one uses the best of equipment, the general opinion seems to be that the change is for the worse. Those British listeners who regarded the 16-metre WCBX, with its remarkable news service, as almost their local station during the crisis and first month of the war, are now disappointed, particularly during the late afternoon and early evening, when there are few alternative sources of news from America.

However, one result of the change has been that these daytime C.B.S. transmissions are now free of sideband interference—and since WCBX has no nearby neighbours on 21.57 Mc/s, except for GST on 21.55 Mc/s (a very weak signal in this country), a highly selective set is no longer *de rigueur*. Unfortunately for C.B.S., the engineering announcements given when WCBX comes on the air are a bit mixed up, since for a week or more the opening announcement has been "WCBX on 21,570 kc/s—16.83 metres!" The inability to think in terms of both frequencies and wavelengths obviously exists amongst C.B.S.

engineers as well as in certain radio circles in this country which shall be nameless!

With the advent of autumn and of decreasing sunlight, the paradox of increased ionisation of the F₂ layer, which occurs regularly at the equinoxes, is again evident from the increasing number of reports of 28 Mc/s reception. Some of the U.S. police transmissions on 33.1 Mc/s have also been heard.

I do not think that 10-metre reception will reach the peak of previous years this autumn and winter, but nevertheless many stations will be well heard, if, unfortunately, not worked. In particular, South African stations will be prominent around 28 Mc/s—ZS1T, for example, and probably the Congo Belge will contribute a phone transmitter or two in this band. In fact, South America and South Africa will remain the stronghold of 28 Mc/s during the coming sunspot minimum years.

Since the curtailment of amateur activities no signals of any importance have been heard on the ultra-high frequencies except diathermy—which is very plentiful and may, I am half afraid, yet constitute a menace which will have to be tackled.

Why not insist on crystal-controlled oscillators for diathermy and allot one frequency, rather like that allocated to the U.S. police transmitter?

Although various claims have been advanced by some medical people that certain wavelengths have certain virtues, I believe those most competent to judge would accept a single frequency, since it is the heating effect of the short-wave energy that is important, and the manner in which this heat may be applied and controlled. This latter condition does not change rapidly with frequency.

Radio engineers who have occasion to look into the windows of shops which supply electro-medical equipment are often amazed at the crudity of the designs and equipment used. The terms used, too, savour of those used by early Italian experimenters rather than conforming to modern radio engineering practice. Where pulses of high-frequency energy are required, for rejuvenating muscles or restoring muscular action by impulsing the nerves, crude interrupters consisting of bent wire prongs dipping into mercury cups and operated mechanically from a metronome appear to be favoured.

Gas-filled triodes (which some manufacturers call thyatrons) have apparently not yet received the attention of our medical colleagues.

So much for diathermy, that spreads its raucous note over the whole of London, and when conditions are favourable over the entire world.

At this time a word of praise is due to the G.P.O. for the manner in which, during the months following the fateful September of last year, it relaxed the regulations somewhat regarding the issuing of amateur transmitting licences and, indeed, encouraged would-be applicants.

I have no doubt that by this action a larger nucleus of skilled and trained radio personnel was made available for immediate absorption into the services than would otherwise have been the case.

Readers of this column will recall that I have constantly advocated that a large amateur body in this country would be of immense value in providing an immediate reserve of skilled technicians, since time is the all-important factor in the training of even radio operators pure and simple.

Perhaps when the war finishes one may look forward to the adoption of the American system of amateur licensing in this country, since the advantage of a large body of active radio amateurs seems already to have been proved up to the hilt. America has over 50,000 amateur transmitters; on the same basis, we ought to have some 20,000.

"ETHACOMBER."

Morse and How to Learn It

RHYTHMIC SOUNDS—NOT DOTS AND DASHES

ACAREFUL study of many of the so-called systems and methods of learning morse which make their appearance from time to time is apt to lead one to the conclusion that a large percentage of them has been evolved by people who have had little or no practical experience in actually using the code as a means of communication. This must not be taken to mean that the people who devise these systems are unprincipled persons who are merely seeking to enrich themselves at the expense of the purchasers of the book expounding their particular method. They probably believe in their own ideas as profoundly as the authors of certain methods of learning foreign languages believe in theirs. In both cases the originators of these ingenious schemes would probably be speedily enlightened if they were marooned in some place in which the foreign language or the morse code, as the case might be, were the only method by which they could converse with their fellow men.

The truth is that there is no royal road whatever to the learning of morse. It is a matter of hard and constant practice, but it will be made ever so much harder if the methods of learning which are sometimes recommended are adopted. Morse, as heard over the air, is a matter of rhythmic sounds denoting letters of the alphabet, and has nothing to do with dots and dashes. It seems almost a pity that convention has had to be followed here to a certain extent, and the letters of the alphabet written down as dots and dashes. It would be ever so much

IN these days men with wireless knowledge are in very great demand, not only in H.M. Forces, but in other branches of National Service. It may truthfully be said of those who aspire to use their wireless knowledge in the service of the nation, that, unless they have a very profound technical knowledge indeed, they cannot afford to be ignorant of morse.

better to use musical notation, and set the dots and dashes down as quavers and dotted crochets, with the appropriate "rests" between them, but unfortunately everybody does not read music.

The best way to explain how to set about learning morse is to consider very briefly where most systems fail. In the morse code the letters of the alphabet, so far as wireless reception is concerned, are denoted by various combinations of a short sound, usually referred to as a dot (•) and a sound exactly three times as long usually referred to as a dash (—). Between each dot and dash there is a space equal to a dot; between each dot-and-dash combination, representing a letter of the alphabet, there is a space equal to three dots, and between each word there is a space equal to five dots. The letter A, for instance, is represented by a short sound followed by an interval of the same length as the sound, and then by a sound three times as long. This combination can easily be whistled or hummed, and will then represent the letter A as heard by wireless. Unfortunately, it is usually called dot-dash and is written down as • — .

The unfortunate effect of this use of the word dot-dash and of the inscription • — may perhaps be realised when it is said that an expert morse operator can easily read at speed a morse message which is whistled or hummed to him. If, however, he sees a message written down as a series of dots and dashes he will usually only be able to read it slowly, and in a halting manner. Similarly, if the sender, instead of humming the sound, actually speaks the words dot and dash when sending the various letters, the receiving operator will be all at sea. This applies also to transmissions. A skilled operator who would have no difficulty in glancing at a page of a book and humming it out rapidly in morse will flounder badly if asked to speak it out by using the words dot and dash, or to write it down, using • and —. As a final word in this matter it may be said that the



How they do it in the R.A.F. In this particular case a loudspeaker is being used instead of headphones.

Morse and How to Learn It—

skilled operator trained to read by sound is usually not much of a hand at deciphering a morse message sent by a signalling lamp or flag.

Having discovered at some length the incorrect way to learn morse, and seen *why* it is incorrect, we are now in a proper position to consider the correct way, and, what is more important, to understand *why* it is

the correct way. To come straight to the point, do not learn that A = ·— or dot-dash. Memorise the fact that A is a short sound followed by a long sound, and so on, as already explained. You can either hum or whistle the various letters of the alphabet yourself, or if you prefer it, can use the word "dit" as representing the short sound, and the word "dah" to represent the long one; actually, of course, this dit-dah business is nothing but a form of humming. Learn all the letters of the alphabet like this.

Incidentally, it will be better if you deliberately jumble the alphabet up, otherwise when, for instance, you want to turn the letter J into morse you will find yourself mentally running through half the alphabet in order to arrive at it. Above all, do not try and "pair" the letters by thinking of N (dah-dit) as being the opposite of A (dit-dah); if you do you will only be laying up trouble for yourself by forming the habit of having to think of A before you can think of its opposite, and so on with certain of the other letters which it is possible to pair in this fashion.

All this time you will not have touched a morse key, nor should you do so until you have fully memorised the code in the manner just detailed. Having memorised the various letters of the alphabet—and also of course the numerals—as rhythmic sounds, try humming or dit-dahing to yourself very slowly, in morse, sentences from the newspaper or from a book, not forgetting that there should be a pause of five "dits" between each word. Do not attempt to do it quickly. Learn to do it slowly, rhythmically and with absolute accuracy. It will be found that speed will come automatically.

The Morse Code

THE ALPHABET

A ·—	N —·
B ····	O ———
C —·—·	P —···
D —··	Q —·—·
E ·	R —··
F ····	S ...
G —··	T —
H ····	U ...
I ..	V ····
J ·——	W —··
K —··	X —···
L —···	Y ———
M ——	Z —···

ACCENTED LETTERS

Ä	·—·—
Å or Ǻ	·—·—·
CH	———
É	·····
Ñ	———·
Ö	——·
Û	·—·—

NUMERALS

1 ·———	6 —····
2 ···—	7 —····
3 ···—	8 —····
4 ···—	9 —····
5 ·····	0 ———

USEFUL PUNCTUATION and OTHER SIGNS

Full Stop (.)	·—·—·
Comma (,)	——·—
Hyphen or Dash (-)	·—·—
Fraction Bar (/)	·—·—
Brackets [()]	——·—
Break or Double Dash (=)	·—·—
Interrogation Mark (?)	·—·—·
Erase (or Error)	·—·—·
End of Message (AR)	·—·—
Closing Down (SK)	·—·—
Wait	·—·—

Making a Start

Now—and not before—you can equip yourself with a key, together with a buzzer or oscillator, and practice sending, but on no account be tempted to touch a key until you can hum or dit-dah messages slowly and accurately, otherwise you will, more likely than not, merely succeed in acquiring an erratic style of sending which will baffle even the secret service department to interpret. If, on the contrary, you *have* done your dit-dahing practice properly, the handling of the key will come quite easily and apparently in an instinctive manner to you. Spacing is perhaps more important than anything, and when first handling a key, particular attention should be paid to it as good spacing leads to clean-cut sending, which is the hall-mark of a good operator.

If you can get hold of a fellow-beginner to learn with you, first practice humming or dit-dahing letters of the alphabet and then words to each other. Soon you will be able to exchange complete messages by this method. When you have thoroughly mastered this phase your friend and yourself can pass on to the use of a key, and you will both find that you will be able almost immediately to send—and what is more important, read quite well—signals which are interchanged between you. It will not be a case of the blind leading the blind as it is usually when two beginners get together with a morse key. Once again, at the risk of being accused of wearisome reiteration, it should be em-

Morse and How to Learn It—

phased that the temptation to send quickly in the initial stages should be resisted. The golden rule is "Look after accuracy, and speed will look after itself."

If you steadfastly think of morse as a matter of rhythmic sounds, and not of dots and dashes, and set to work to learn it as such, in the manner detailed in this article, you will be amazed at the relatively quick progress you will make. If you can get another beginner to co-operate with you as suggested, you will get on better still; in fact, it may almost be said that a beginner who is really willing to co-operate in the manner suggested might be the means of your learning

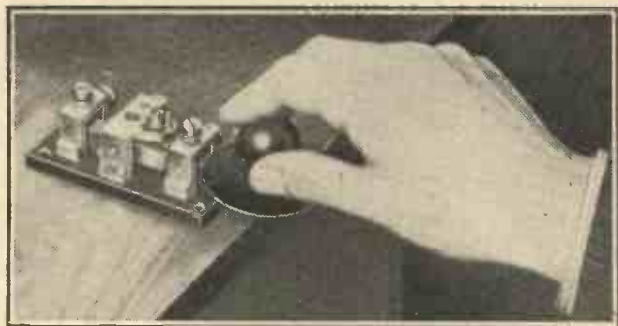

The correct handling of the key, which is illustrated here, is very important. The knob is held lightly between the first two fingers and the thumb, as shown, while the forearm is in line with the bar of the key. Signalling is effected by dropping the wrist.

more quickly and accurately than if you collaborated with a skilled operator, who might perhaps be inclined to attempt to teach you to run before you could walk.

Those who want further information on this method of learning morse should consult the sixpenny booklet on the subject which is issued by this journal. In it there is also a description of how to make a simple morse practice set employing a valve oscillator, which will be found a more satisfactory arrangement than a buzzer, since it reproduces the tone of the signals heard in actual wireless working.

Lighting for A.R.P. Shelters

AVOIDING RISK OF SHOCK

THE lighting of trenches and dugouts for A.R.P. purposes is rather outside the normal scope of this journal, but a few notes may be acceptable to those radio men who are forced by popular demand to act as electrical advisers to all and sundry.

The mains supply must not be used, under any circumstances, in damp places; the risk of a shock proving fatal is far too great. Hence the most elementary arrangement will consist of a transformer stepping down to either 12V. or 6V. followed by a low-voltage line to the trench or dugout, in which motor car head-lamp bulbs are fitted. One side of the line should be effectively earthed.

When fixing preliminary details, two points should be borne in mind. First, low-voltage lamps take a corre-

spondingly higher current. Hence the resistance of the line must be sufficiently low to avoid any considerable voltage drop. This loss may be calculated by using Ohms Law: voltage dropped equals the line resistance in ohms multiplied by the current in amperes. Secondly, dirty boards, earth, etc., absorb light rather efficiently. Free use of whitewash or weatherproof distemper will do more to improve the general illumination than adding to the candle-power of the lamps used.

The foregoing scheme is entirely satisfactory providing the electric supply is functioning. If it fails, the lights will go out. An easy way of preventing this possibility is to install a car battery complete with charger. Incidentally, if the car is out of use, the battery can be taken out and kept in perfect condition in this way.

A good selection of metal rectifiers with different current ratings is available for either 12V. or 6V. batteries, and the circuit connections and transformer requirements can be obtained from the manufacturers. Two alternative schemes for charging are feasible. The charging current can be quite small, say, 0.5 amp., and left on for some hours each week, depending upon the amount of use. Or, the charging current can be, say, 0.5 amp. in excess of the total current taken by the lighting system. In this case the accumulator will be charging slowly while the lights are on, and there will be no need to bother about charging at other times. Linked switches or a double-pole switch can be wired so as to ensure that the charger is automatically switched on at the same time as the lights. Clearly, discharge will occur only when the mains fail, and this should be very infrequently. The latter scheme is more trouble-free and foolproof, but a little more expensive to install.

Again the warning . . . guard against shock. Keep the mains voltage away from damp places and soundly earth one side of the low-voltage system. Also use a transformer having unimpeachable insulation. N. P.

Harbinger of the New Year

THE appearance of *The Wireless World Diary* for 1940 in its customary and normal form is unusually welcome in these troublous times as a reminder that war has not engulfed all the ordinary interests of life. The very complete list of short wave wireless stations, which is to be found in it, will be especially valuable now that there is so much of interest to be heard at all hours of the day and night on this part of the spectrum. A complete list is also given of new medium and long wavelengths which, war or no war, should come into force on March 4th when the Montreux Plan is due to be put into operation.

Another feature of great interest which again makes its appearance is the valve data section, which gives technical details of all British and many of the American and Continental valves. Other data in the diary include familiar formulæ of the type which are frequently required but not often remembered when wanted. A considerable amount of new matter has been introduced, and some of the familiar features appear in a more handy form. Probably one of the most valuable sections is that giving circuit diagrams and data; this has been brought completely up to date.

The diary can be obtained from Iliffe and Sons Ltd., Dorset House, Stamford Street, London, S.E.1, at a cost of 1s. 6d., or 1s. 7d. post free.

Pye "International" Model 906

AC TABLE MODEL SUPERHET (FOUR VALVE + RECTIFIER). BAND SPREAD TUNING ON SIX SHORT-WAVE RANGES. Price 16½ Guineas

STATION-CALIBRATED dials for medium and long waves have long been a commonplace in broadcast receivers, but on the short-wave ranges manufacturers have hitherto done little more than indicate the sequence of stations to be found on any given waveband, leaving the user to locate their exact settings as best he may. Sometimes an arbitrary "degree" scale has been included from which numbers corresponding to each station can be logged, but this savours somewhat of the scientific instru-

SETS FOR WARTIME

AS the centre of interest in broadcasting has shifted from normal wavelengths to the short-wave bands we have arranged to review a number of sets in which special attention has been given to short-wave performance

ment and is contrary to the trend towards simplification of tuning for the layman.

In the Pye "International" the short waves have been accorded the same treatment as medium and long waves in the matter of station calibration. Each individual short-wave transmitter has its place on the dial and one can bring the pointer straight to it without "feeling about in the ether" or hunting for notes of station settings.

Circuit.—The basic circuit is no more complicated than that of the average table model superhet. Its chief interest lies in the design of the tuned RF circuits associated with the

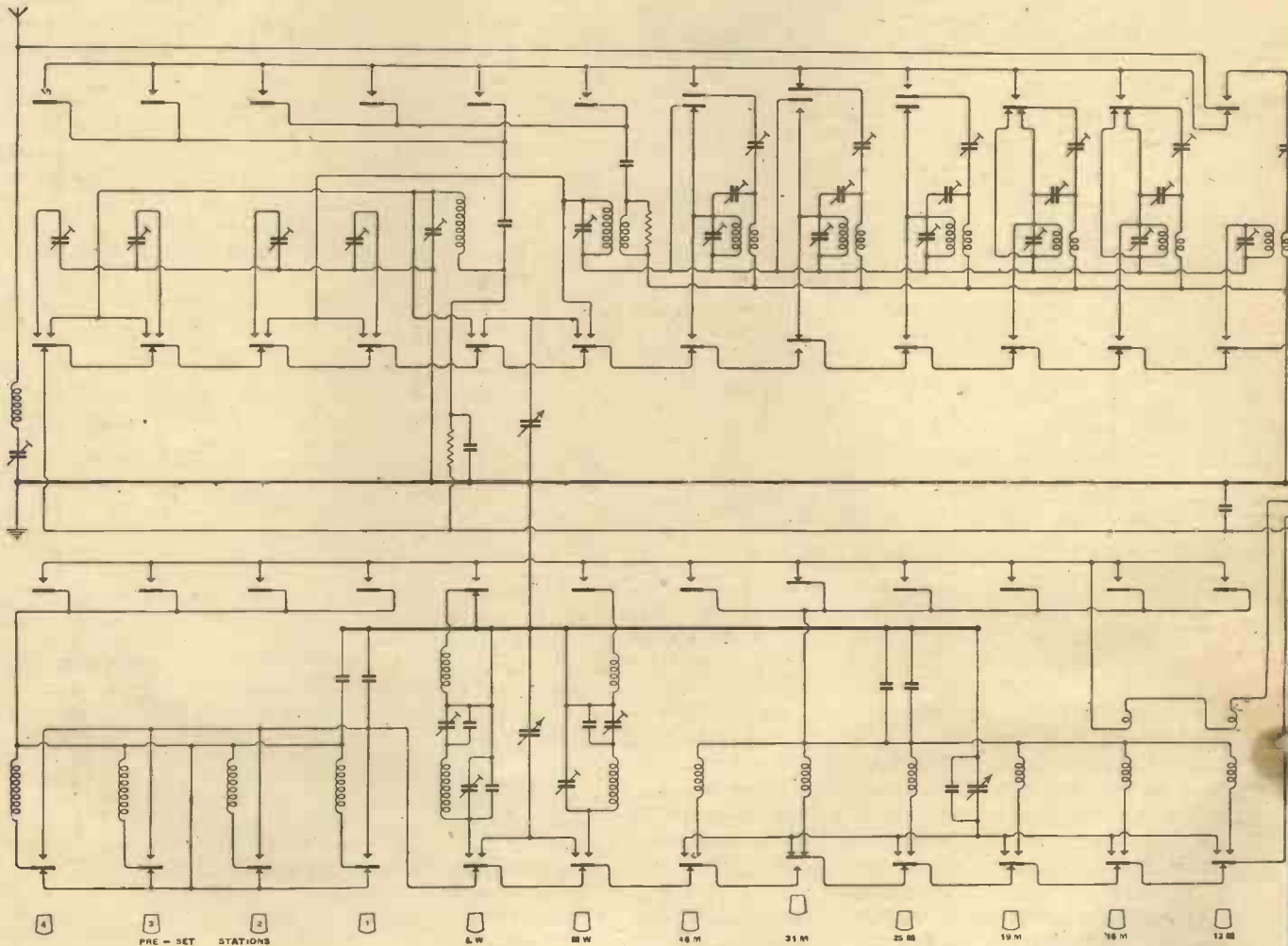

Wireless World

Pye "International" Model 906— frequency changer. On medium and long waves a normal two-gang condenser tunes the aerial and oscillator circuits. On short waves the tuning of the aerial circuit is fixed on each waveband and a separate tuning condenser of lower capacity is used to "band-spread" the oscillator circuit.

Each oscillator circuit is adjusted by the inductance of the anode coil which has a screwed iron-dust core. The minimum capacity is fixed, and to ensure that the scale calibration shall hold, great care has been taken to obtain exact similarity in the wiring between one set and the next. A composite padding condenser with a proportion of ceramic dielectric compensates for the effects of temperature in other parts of the circuit.

Since only one tuned RF circuit precedes the frequency-changer,

Waveband switching is by means of press buttons, and in addition there are four buttons for pre-tuned stations, two on medium and two on long waves. The circuit is changed from radio to gramophone by a push button, but the on-off switch is incorporated with the volume control.

The first valve in the circuit, a triode-hexode frequency-changer, is used in a neutralised circuit and is controlled by a fraction of the delayed AVC voltage applied to the IF stage. Stable fixed capacities are used in the IF transformers, which are tuned by adjusting their cores.

Interest in the detector and output stages centres around the arrangements which have been made for tone control. A four-position switch gives two degrees of top cut in the first two positions by connecting a resistance-capacity shunt across the anode circuit of the output valve.

10 kc/s channel on each waveband. On the 13- and 16-metre bands the station marks are little wider than the pointer itself, yet the registrations were found to be exact in every case. The stations on these bands are comparatively few and they are grouped near the centre of the scale near the point at which the circuits are aligned. On the 10, 25, 31 and 49-metre bands a discrepancy amounting to half a channel was observed on some stations near the ends of the scale, but over the greater part of the scale the registration was within the latitude represented by the width of the marks.

Higher accuracy than this is seldom achieved even on medium and long waves, and we can fairly say that the designer's boldness in attempting short-wave calibration has been rewarded with success.

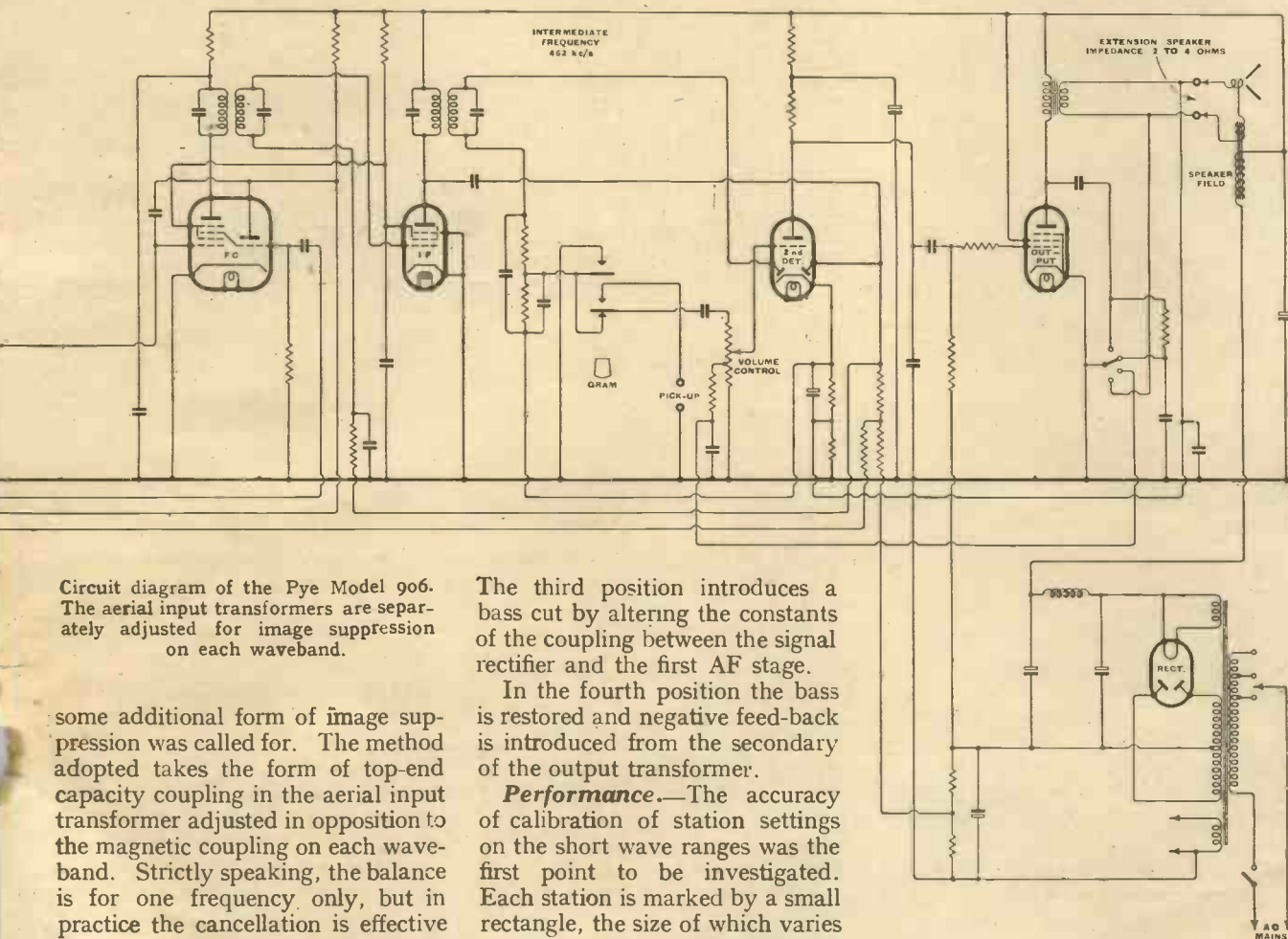

Circuit diagram of the Pye Model 906. The aerial input transformers are separately adjusted for image suppression on each waveband.

some additional form of image suppression was called for. The method adopted takes the form of top-end capacity coupling in the aerial input transformer adjusted in opposition to the magnetic coupling on each waveband. Strictly speaking, the balance is for one frequency only, but in practice the cancellation is effective over a considerable part of the band.

The third position introduces a bass cut by altering the constants of the coupling between the signal rectifier and the first AF stage.

In the fourth position the bass is restored and negative feed-back is introduced from the secondary of the output transformer.

Performance.—The accuracy of calibration of station settings on the short wave ranges was the first point to be investigated. Each station is marked by a small rectangle, the size of which varies according to space occupied by a

Pye "International" Model 906—

As far as sensitivity and signal-to-noise ratio are concerned, the performance is equal to that of many sets with an RF stage before the frequency changer. Certainly it is vastly superior to the "all-wave" sets of a year ago with an equivalent number of valves. The set speaks with a directness of utterance which leaves no doubt as to whether

WAVERANGES

13 M	13.7-14.2	metres
16 M	16.5-17.1	"
19 M	19.3-20.1	"
25 M	24.8-25.8	"
31 M	30.6-31.9	"
49 M	48-50	"
Medium	180-560	"
Long	850-2000	"

The reproduction has a clarity which is admirably suited to the requirements of long-distance short-wave listening. We found the position of the tone control marked "Less Bass" to be best suited for this purpose. The fact that full high note response is maintained with this setting is a tribute to the good signal-to-noise ratio, for most receivers call for a top cut under these conditions.

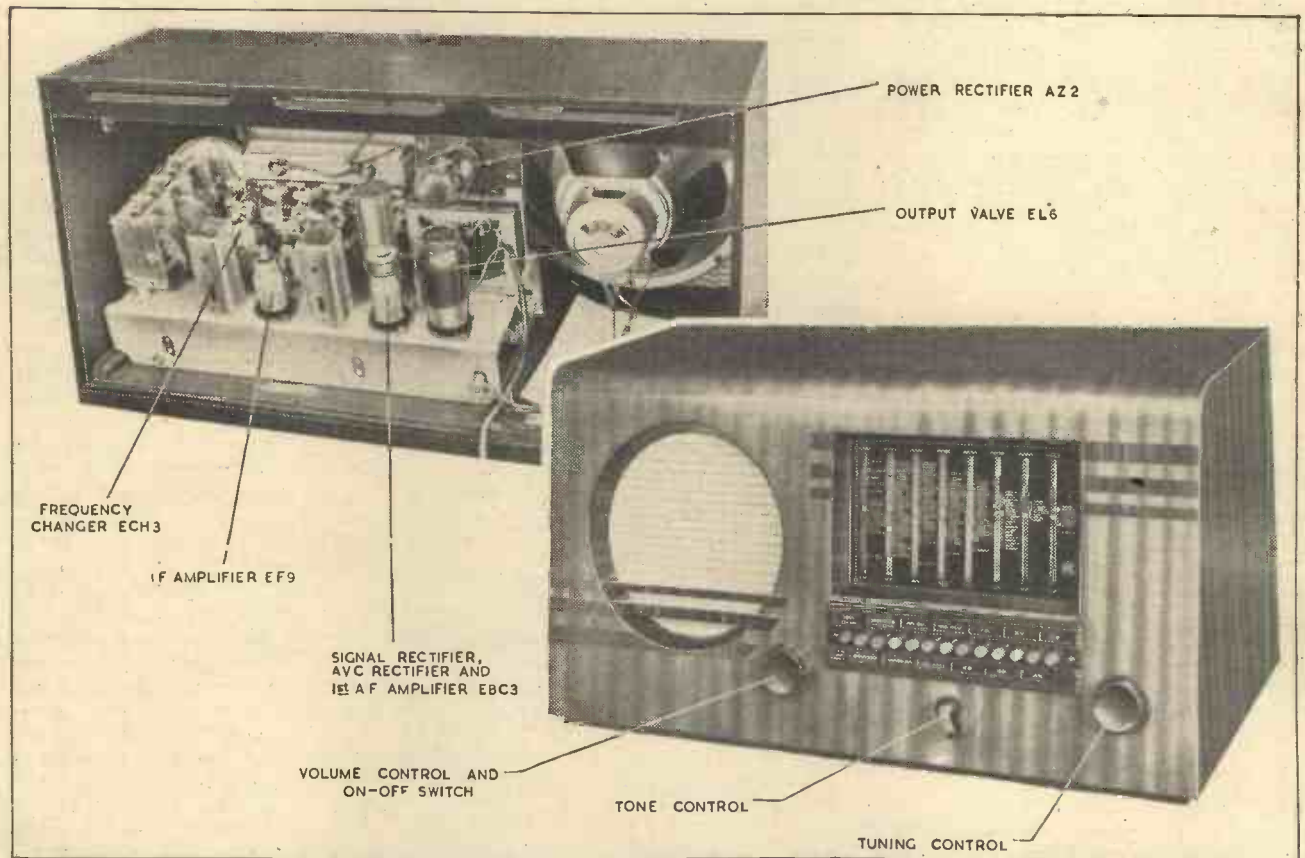

Layout of valves and controls in the Pye "International." A separate section of the tuning condenser is used for oscillator band spread tuning on the short-wave range.

any particular station is working or not. With the clearly arranged dial and push-button waverange selection it is but the work of a moment to switch to another channel if one's favourite station is not coming over as it should. The necessary overall amplification is there on every range, including the 13-metre, and given a normal aerial system any signal above the prevailing background will be received with certainty.

Much of the high performance is due to the careful design of the tuned circuits and the image suppression is very satisfactory. One or two

whistles of variable pitch indicated the break through of powerful CW transmissions on the higher wavebands, but repeat tuning points on broadcast transmissions were absent on all waveranges.

The absence of a tuning indicator was at first deplored, but subsequent experience showed it to be unnecessary. The tuning is so open and the scale so clearly marked that one instinctively tunes accurately by co-ordination of eye and ear. The open tuning does not reveal any serious temperature drift during the warming-up period.

There is a considerable drop in amplification when the "High-Fidelity" setting of the tone control is used, but after compensating for this with the volume control one can go to a much higher level without provoking distortion.

By alternating between these two positions of the tone control the properties of negative feed-back can be very conveniently demonstrated.

Constructional Details.—The push buttons for waverange selection are moulded in a translucent material which is illuminated from a general

Pye "International" Model 906—internal source when any given button is depressed. Normally the light is excluded by a felt ring between the base of the push button and the escutcheon plate.

With electrical band-spread tuning in the short-wave ranges the reduction gear ratio of the tuning control has been kept the same as that normally required for medium and long waves. Rapid movement from one part of the scale to another is facilitated by a flywheel incorporated in the control mechanism. This has just the right inertia and gives a very pleasant "feel" to the control without any tendency to overshoot.

Summary.—The ability to see the whole wavelength spectrum and one's position in it at a glance is an advantage which, once experienced, one is not likely to forgo. Backed by high circuit efficiency down to the lowest wavelengths this feature will ensure for the Pye "International" a high place in any selection list of S.W. "specials."

Makers: Pye, Ltd., Radio Works Cambridge.

Self-contained Petrol Electric Generators

A WIDE selection of "Pioneer" portable lighting plants, ranging in price from £11 to £100, is available from the British Motor Boat Manu-

facturing Co., Ltd., Britannia House, Ampton Street, London, W.C.1. These units, which in general have a very low weight-to-power ratio, are suitable for battery charging and for 230-volt AC supply for PA installations where mains are not available.

The "Blue Diamond" model gives 300 watts AC at 230 volts and 250 watts DC at 12 volts, and weighs less than 100lb. Its overall dimensions are 19½ in. x 14 in. x 14 in., and the price is £27 10s.

For battery charging the "Champion" series is suitable, and may be obtained with outputs of 175 or 200 watts at 6, 12 or 32 volts. Prices range from £19 to £24, and the dimensions of this compact unit are only 11½ in. x 15½ in. x 13½ in. The weight is 5½ lb.

All engines in the "Pioneer" range work on the 4-stroke principle, and in many cases can be obtained with push-button starting off the charging battery.

Battery SW Converter

ADAPTING AN AC DESIGN

A READER who uses a small battery superheterodyne for broadcast reception requires a converter for short-wave listening and asks if it would be possible to modify the Three-Range Short-Wave Converter described in our issues of April 9th and 16th, 1937, so that it could be used with his set.

The converter in question was designed for AC sets, but there is no reason why the same general idea should not be employed with a battery frequency changer in place of the AC valve used in the original model.

A Marconi or Osram X23 should function quite satisfactorily if a few modifications were made, and these are indicated in the circuit shown here.

The coils, switching and the same form of construction can be adopted, but where resistances and condensers

of different value are needed they are given RX or CX numbers. Elsewhere the component markings as appeared in the original circuit are retained. Though the sequence is not continuous, this will facilitate following the original circuit.

It will be noticed on comparing the circuit here and the original one that the grid resistance R1 is shown dotted as it might be possible to dispense with it. Alternatively, a resistance of about 5 to 10 ohms made up from a few inches of resistance wire wound on a match stick could be inserted in the screen-grid lead of the valve between the point marked Y and the valve-holder socket. R1 was included to suppress what appeared to be parasitic oscillation in the valve, but a screen-grid resistance inserted between the valve pin and the by-pass condenser has subsequently proved a more satisfactory remedy. It is, of course, not always necessary

necessary

The damping resistances across the oscillator coils L8 and L9 are omitted, but they may have to be reinstated if the oscillator RF volts are found to exceed the optimum value for the X23.

The unit could be simplified by omitting the convenience of waveband switching and using plug-in coils, and provided coils with inductance the same as the originals are fitted the padding condensers C12, C13 and C14 will not require to be changed. These condensers would, of course, be embodied in the plug-in coil.

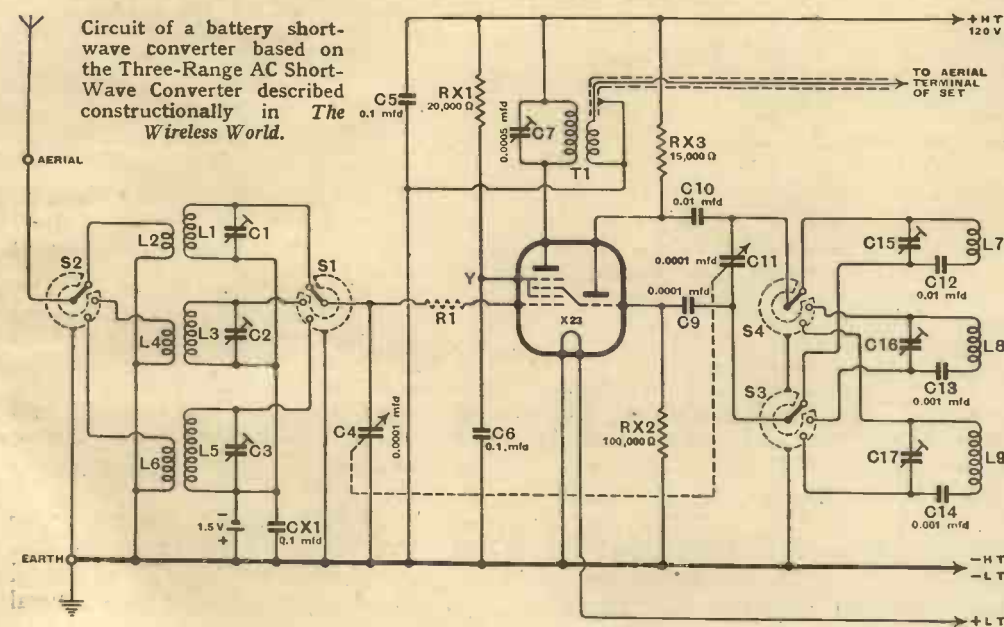

Current Topics

CHANGES IN B.B.C. CONTROL

Transfer of Charter Powers : Two Governors Instead of Seven

SWEEPING changes in the control of the B.B.C. have been introduced in the past few weeks.

First, the powers held by the Postmaster-General under the Charter and Licence of the B.B.C., other than those relating to technical matters affecting wireless traffic, have been transferred to the Ministry of Information. This transfer, however, does not alter in any way the relations between the Government and the Corporation and, moreover, the Minister of Information has no power to interfere with the discretion of the Corporation in its choice of entertainment programmes.

The second change was the reduction of the number of Governors from seven to two, provision for which is contained in the Charter.

In announcing these changes in the House of Commons on September 28th, Mr. Chamberlain said "The new arrangements do not alter the structure or constitution of the Corporation, and the interests of listeners and accepted principles of broadcasting policy will be fully safeguarded. In respect of censorship and the news, the Corporation is in the same position as the Press."

The powers transferred to Lord Macmillan, Minister of Information, though not extensive, include the power to prescribe broadcasting hours and to veto any broadcasting matter

which is not in the public interest. The transference also relates to the possible control of the service in emergency.

The two Governors now constituting the Board are Sir Allan Powell, who was appointed chairman in March this year, and Mr. C. H. G. Millis, vice-chairman since 1937.

The appointment of the remaining five governors was terminated by Order in Council as from September 5th, although it was not announced until September 27th. The retiring Governors and the dates of their appointments are: Mr. H. A. L. Fisher, 1935; Caroline, Viscountess Bridgeman, 1935; Captain Sir Ian Fraser, 1936; Mr. J. J. Mallon, 1936; and Miss Sara Margery Fry, 1938.

Sir Samuel Hoare, Home Secretary, in reply to criticisms of the changes, said, in the House of Commons on October 11th, "There was a question at one time whether the Government in wartime should take over the B.B.C. altogether. It was felt, however, that the relations between the Government and the B.B.C. should be substantially the same as in peacetime.

"Of their own volition the Board agreed that the powers during wartime should be delegated to the chairman and vice-chairman. It was simply a matter of efficiency, and to avoid delay."

RELAY EXCHANGES

Land Lines to B.B.C. Studios

THE possibility of linking radio relay exchanges by land lines to B.B.C. studios has for some time been under consideration by the Post Office.

Under present conditions the Post Office sees no prospect of being able to provide lines to provincial relay exchanges generally or on any considerable scale, although it may be able to meet individual applications from exchanges which are situated in close proximity to a B.B.C. studio.

The rent for the lines would have to be calculated separately in each case, and would approximate to the ordinary private wire tariff, with special consideration to any case

where a line served more than one exchange.

The Post Office has already provided emergency lines for certain of the London relay companies, and has authorised Western Wireless Relay to negotiate with the B.B.C. regarding the provision of a connection with the nearest studio.

It is emphasised by the Post Office that any action taken at this stage must not be regarded as prejudicing in any way the general question of providing land lines between relay exchanges and B.B.C. stations, under special provisions in regard to rental, which has been the subject of discussion between representatives of the relay industry and the Post Office.

COLUMBIA'S FREQUENCY-MODULATED TRANSMISSIONS

Major Armstrong's Station to be Used

INTERFERENCE-FREE, distortionless, realistic reception of the Columbia Broadcasting System's evening programmes are now made available to New Yorkers who have frequency-modulation receivers. The transmissions are on 42.8 Mc/s from W₂XMN, Alpine, N.J., the 40-kW station of Major Armstrong, who is Professor of Electrical Engineering at Columbia University and inventor of the F-M system of transmission.

Announcing this arrangement, the C.B.S. gives for its less technical listeners a description of the system.

"Boiled down to essentials, the difference between present-day amplitude-modulated broadcasting and Major Armstrong's frequency-modulation could be likened to the difference between a searchlight operated with and without a shutter. Columbia's WABC operates like a searchlight beamed on a listener's home, the beam staying continually on 860 kc/s while the intensity of the light changes constantly as if actuated by a shutter.

"In Major Armstrong's method (if likened to a searchlight's beam) the intensity of light remains constant while the beam swings continually to the right and left of the frequency on which it operates."

It is pointed out by C.B.S. that frequency-modulated transmission cannot be used in the medium-wave band because it requires a channel width 20 times greater than ordinary amplitude modulation.

SWISS BROADCASTING

Radio-Nations

ALTHOUGH it is understood that the convention between the Swiss Government and the League of Nations regarding the short-wave station, Radio-Nations, at Prangins, provides for the League taking over the station at a time of crisis, this has not been done. At present, the station which is normally operated by the Swiss Broadcasting Company with special times for League transmissions has, like all the Swiss stations, been taken over by the Ministry of Posts and Railways.

The Swiss broadcasting service is now conducted from three main studios—one for each of the three language-region transmissions.

THE B.B.C.'s HOME SERVICE

Sir Noel Ashbridge Replies to Critics

WHILST some of the criticisms of the B.B.C. and its wartime activities (or inactivity) have been justified, others have been purely for want of thought.

Speaking from the technical aspect of the B.B.C.'s home service, Sir Noel Ashbridge recently said that it was known before the single-programme scheme was put into operation that certain districts would suffer. Actually, from ten to twenty per cent. of listeners were getting poor reception due to fading and distortion.

The single programme service was not the B.B.C.'s idea, but was introduced at the instigation of a Government department "in the interests of national security."

Sir Noel said: "I would certainly not go so far as to say that it will not be possible to devise some means of giving a better service to listeners—we are working on possibilities. An alternative programme, however, is not at present contemplated."

The only answer he was able to give to many of the questions put to him was that the steps had been taken "for reasons of national security."

AMERICAN INTERNATIONAL SHORT-WAVE STATIONS

New Call Signs and Frequencies

LISTENERS to American international short-wave stations are experiencing some difficulty in identifying them owing to the changes recently made in the call signs. In some cases they have been changed twice in the past six or eight weeks.

To clarify the position we are publishing below a list giving the old and new call sign, together with the frequencies allocated and the authorised power of each station.

Old	Call Signs New	Station	Frequencies (Mc/s)	Power (kW)
WIXAL	WRUL†	World Wide B. Fdtn., Boston	6.04, 11.73, 11.79 15.13, 15.25, 21.46	20
WIXAR	WRUW	World Wide B. Fdtn., Boston	11.73, 15.13, 25.6	20
W3XAU	WCAB†	WCAU Brdestg. Co., Philadelphia	6.06, 9.59, 15.27 21.52, 25.725	10
W8XAL	WLWO	Crosley Corp., Cincinnati	6.06, 9.95, 11.87 15.27, 17.76, 21.65	10*
W3XL	WNBI	N.B.C., Bound Brook	6.10, 17.78	35
W3XAL	WRCA†	N.B.C., Bound Brook	9.67, 21.63	35
W2XE	WCBX†	C.B.S., Wayne	6.12, 6.17, 9.65 11.83, 15.27, 17.83 21.57	10
W8XK	WPIT	Westinghouse, Pittsburgh	6.14, 9.57, 11.87 15.21, 17.78, 21.54	40
W1XK	WBOS	Westinghouse, Millis	9.57	10
W2XAF	WGEO	G.E.C., Schenectady	6.19, 9.53, 21.59	100
W2XAD	WGEA	G.E.C., Schenectady	9.55, 15.33, 21.5	25
W6XBE	KGEI	G.E.C., San Francisco	6.19, 9.53, 15.33	20

† Recent changes: WRUL was WSLR; WCAB was WCAI; WCBX was WCBS.

* Also uses 50 kW experimentally.

† Beamed continuously on Latin America.

* Beamed continuously on Europe.



DEMOUNTABLE TRIODE VALVES.

The electrode assembly of the new demountable triode valves of the continuously-evacuated type which have been developed by the General Electric engineers at Schenectady for the Company's 100-kW short-wave station WGEO. Whilst the B.B.C. uses large demountable screen-grid valves for some transmitters, the new American triodes are the largest of their kind in the world.

AIR MINISTRY TECHNICAL STAFF

IT may not be generally known that civilians with high technical qualifications may still apply for commissions to serve as Signals Officers in the Royal Air Force. Applications, marked "For the attention of Signals 1(A)," should be sent to the Under Secretary of State, Air Ministry, Kingsway, London, W.C.2.

B.B.C. EUROPEAN NEWS BULLETINS

Broadcasts in Eleven Languages

THE B.B.C. is now maintaining two overseas services—the world service operating for 22 hours a day and the European service, which operates for 19 hours.

The service intended for Europe is broadcast between 5.57 a.m. and 5 p.m. G.M.T. on GSW 7.23 Mc/s (41.49 m.) and GSE 11.86 Mc/s (25.29 m.) and between 5.17 p.m. and 2 a.m. on GSA 6.05 Mc/s (49.59 m.) and GRX 9.69 Mc/s (30.96 m.). Between the hours of 6 p.m.-2.15 a.m. and 5.57-7.30 a.m. all transmissions, except the news bulletins in English, are also radiated on 261.1 metres.

The following list gives the times (G.M.T.) of the bulletins which are broadcast, according to the time of day, on the frequencies given above:—

English.—12.30, 6.15, 8, 9, 10.45, 11.30 a.m., 1.15, 4, 5.30, 7, 10, 11.30 p.m.
 French.—12.15-12.30; 7.15-7.30; 9-9.15; 11.45 p.m.-12 (midnight).
 Italian.—12.45-1; 6.30-6.45; 9.45-10 p.m.
 Polish.—2.15-2.30; 8-8.15 p.m.
 Czech.—1.45-2; 7.45-8 p.m.
 Spanish.—1.7-1.15; 2-2.15 a.m. 2-2.15; 10.15-10.30 p.m.
 Portuguese.—12 (midnight)-12.15; 1-1.7 a.m.; 1-1.15; 10.30-10.45 p.m.
 German.—12.30-12.45; 7.30-7.45; 9.15-9.45 p.m.
 Rumanian.—8.30-8.45 p.m.
 Serbo-Croat.—8.45-9 p.m.
 Magyar.—8.15-8.30 p.m.

AMATEURS

Experimental Work to Continue

IN a message from the Council of the Radio Society of Great Britain to its members it is recommended that they should, as far as circumstances permit, carry on with experimental work within the terms of their normal receiving licences. In particular, it is hoped that members will endeavour to correlate information concerning general conditions so that a monthly summary may be recorded.

With the suspension of the autumn and winter R.S.G.B. meetings, which are normally held at the I.E.E. in London, it has been decided to discontinue for the duration of the war the special London fee of £1 rs. and to institute a flat rate annual subscription of 15s. for the whole country; the overseas subscription remains unchanged at 12s. 6d.

R.S.G.B. members serving with the armed forces are "for the duration" to pay a reduced annual subscription of 10s. Mr. A. E. Watts, President of the Council, in a message to members with the forces says: "To you in particular we extend our best wishes and offer you individually good luck and

Wireless World

Current Topics—

God speed. May the 'ham spirit' which you have helped to create see you through your darkest moments."

BROADCAST TELEVISION LECTURES

WEEKLY lectures on television have been given by Dr. C. Davis Belcher from the World Wide Broadcasting Foundation's short-wave station, WRUL (ex WIXAL) since September 18th.

The lectures have covered the latest developments in the fields of transmission and reception. The last two of the series, which will be given on Mondays, October 23rd and 30th, will cover ultra-high frequency characteristics and television receiving aeriels. Initially radiated on 6.04 Mc/s at 10.30 p.m. G.M.T., the lectures are repeated on Tuesdays at 2 a.m. on 11.73 Mc/s and again on Fridays at 8 p.m. on 11.79 Mc/s.

U.S.A. TELEVISION REPORT

SOME delay in the correlation of data regarding propagation and transmission characteristics of the frequencies allocated to American television transmitters has created complications in the drafting of the tele-

vision report by a committee of the Federal Communications Commission which should have been presented by September 1st.

It is learned from our American contemporary, *Broadcasting*, that the findings of the engineering committee of the American Radio Manufacturers' Association is awaited, for it is felt that it will indicate more or less conclusively the dependable service areas of present stations. This will then determine the distances which must separate television stations using the same frequencies.

FROM ALL QUARTERS

Emergency Addresses

To avoid any delay by inaccurate addressing of correspondence, we would point out that whilst the Marconi Company has, as stated in our issue of September 28th, moved to Great Baddow, the British Licensing Pool is still operating from the Marconi offices, Electra House, Victoria Embankment, London, W.C.2.

Two additions to the lists published in our issues of September 14th, 21st and 28th are given below:—

The Institute of Wireless Technology, 25, Firs Drive, Palmers Green, London, N.13.
Westinghouse Brake and Signal Company, Pew Hill House, Chippenham, Wilts. (Tel.: Chippenham 2255.)

Slovaks' Pre-Tuned Sets

It is reported that Slovakian listeners have been ordered to have their sets pre-tuned for listening to Slovakian and German transmitters only. The cost is to be borne by the listener.

Mr. F. R. W. Strafford

FORMERLY chief research engineer of Belling and Lee, Ltd., Mr. F. R. W. Strafford has been appointed technical manager of the Company.

Radio in Malaya

The first Malayan all-radio exhibition was held in a Chinese amusement park in Singapore a short time ago, and it is interesting to recall that the General Electric Company were encouraged by the preference for all-British receivers. The public were initiated into the secrets of broadcasting through an exhibit by the British Malaya Broadcasting Corporation, which consisted of an open studio from which actual transmissions were broadcast.

Wireless Engineers' Register

THE British Institution of Radio Engineers is compiling a register of those having qualifications fitting them for national service in the wireless branches.

In Lighter Vein

UNDER the heading "Preservation of National Monuments," a cartoon in a French paper depicts two little gutter urchins staring up at the Eiffel Tower with one of them asking the question, "Wonder how many sandbags will be required for that?"

NEWS IN ENGLISH FROM ABROAD: Regular Short-Wave Transmissions

Country : Station	Mc/s	Metres	Daily Bulletins (G.M.T.)	Country : Station	Mc/s	Metres	Daily Bulletins (G.M.T.)
America				Russia			
WNBI (Bound Brook)	17.78	16.87	3.0 a.m., 5.0, 6.0.	RNE (Moscow)	12.0	25.0	11.0 a.m.†, 3.0†, 9.30, 10.30, 12 midnight.
WRCA (Bound Brook)	9.67	31.02	3.0 a.m., 5.0.	RW96	6.03	49.75	8.0, 10.30, 12 midnight.
WCBX (Wayne)	11.83	25.36	4.0 a.m.	9.52	31.51	8.0, 10.30.
WGEO (Schenectady) ..	9.53	16.83	2.25*†, 6.30, 10.50.	15.18	19.76	8.0 a.m.
WGEA (Schenectady) ..	15.27	31.48	4.0 a.m.†, 9.55, 11.25.*	RKI	7.51	39.89	9.30, 10.30.
.. ..	15.33	19.65	9.55.	15.04	19.95	12.0 midnight.
.. ..	21.5	13.95	2.0.	RAL	9.60	31.25	8.0, 9.30, 12.0 midnight.
WPIT (Pittsburgh) ..	11.87	25.26	4.0 a.m., 11.45.	11.641	25.77	11.0 a.m., 8.0.
.. ..	16.21	19.72	5.0, 6.0.	Yugoslavia			
.. ..	21.53	13.93	1.0, 2.0.	YUA (Belgrade)	6.1	49.18	9.0.
WCAB (Philadelphia) ..	6.06	49.5	3.30 a.m.†	YUC	9.505	31.56	9.0.
.. ..	15.27	19.65	5.15, 7.0, 11.0.*	Japan			
WRUL (Boston)	6.04	49.67	4.0.	JZJ (Tokio)	11.8	25.42	12.30, 8.5.
.. ..	11.73	25.58	8.0.	JZK	15.16	19.79	12.30, 8.5.
.. ..	11.79	25.45	11.0.	China			
Italy				XGOY (Chungking)	9.5	31.58	11.0.
I2RO3 (Rome)	9.63	31.15	12.30 a.m., 6.18.	Spain			
I2RO4	11.81	25.40	12.30 a.m., 11.0 a.m., 4.0, 6.18, 10.0.	FETI (Valladolid)	7.07	42.43	7.45.
I2RO6	15.30	19.61	12.30 a.m., 9.45 a.m., 4.0.	Australia			
I2RO8	17.82	16.83	11.0 a.m.	VLR (Melbourne)	9.58	31.32	8.45 a.m. (9.20 a.m. Sun.), 12.30 (12.15 Sun.).
I2RO9	9.67	31.02	11.16.	VLR3	11.88	25.25	2.20 a.m., 8.30, 10.30.
IRF	9.835	30.52	12.30 a.m.	Iceland			
France				TFJ (Reykjavik)	12.235	24.52	6.40.
TPB6 (Paris-Mondial) ..	15.13	19.83	8.15 a.m.				
TPB11	7.28	41.21	7.0.				
TPA2	15.243	19.68	11.0 a.m.				
TPA4	11.718	25.6	3.0 a.m.				
TPA4	11.885	25.24	3.0 a.m., 8.15 a.m., 7.0.				

All times are p.m. unless otherwise stated. * Saturdays only. † Sundays only.

Unbiased

By FREE GRID

Great Oaks . . .

IT seems somewhat strange at present to see *The Wireless World* as a monthly again as it started life way back in 1911, nearly thirty years ago. It has reminded me rather forcibly of the time when I first became acquainted with the journal, which was rather more years ago than I care to remember. I recollect that I came into contact with it very suddenly, and very violently, as I was rounding the corner of a passage at school, and collided with the librarian, who was staggering along with a pile of books, on the top of which was a volume of this venerable journal. The outcome of the collision was the upsetting of the pile of books, with the result that the weighty words of the Editor descended heavily on to the top of my skull, making an impression on it which has lasted to this very day.

By such small and apparently trivial happenings are our destinies guided, for it is by no means impossible that, had not wireless and *The Wireless World* so forcibly im-



Making an impression.

pressed themselves upon me then, when I was at a highly impressionable age, you and I would never have made each other's acquaintance, and the wireless manufacturers would have gone sublimely on their way, unrebuked and unhindered by me, ignoring our needs, and trampling us under foot in the manner of a gentleman we all know, and whom, as I don't want to get something heavier than a volume of *The Wireless World* dropped on my head, we

will leave unnamed. Had not this momentous dropping of *The Wireless World* occurred—in its way fully as momentous as the apple which fell on the head of Sir Isaac Newton—I might never have interested myself in wireless at all; I might, in fact, have become a High Court Judge, or a fish and chip merchant, serving our National Press by providing it with precious *bon mots* with which to fill its columns, or serving it by using the aforesaid columns to wrap up my piscatorial wares.

Officialdom Run Riot

However, I digress. What I set out to talk to you about was wireless and carrier pigeons, and I propose, by special favour of the Ministry of Information, to give you a few details concerning some work I have been contemplating doing for the Government. I am, unfortunately, forbidden by the censor to tell you what carrier pigeons do for a living, but probably some of the more intelligent among you may guess. There have, I regret to say, been severe casualties among them, owing to the lack of co-operation among certain Government Departments.

Although you will, I know, scarcely credit it, in the development of its (CENSORED), not one Government official thought of the idea of putting corks on the anchor wires so that the pigeons could see them. The result I must leave to your imagination. Even now, when so much havoc has been wrought in the pigeon world, nothing has been done, simply because some purblind official at the Ministry of Supply refuses to release the necessary quantity of corks without the proper requisition form being filled up, and as no such forms exist there is a complete deadlock.

I would take it upon myself to ask you to send me all the corks you can lay your hands on, but, unfortunately, as I know to my cost, most of the readers of *The Wireless World* are teetotallers, and so there is no hope in that quarter. Probably,

however, some of you may remember in the far-off days of peace a lot of correspondence in *The Wireless World* on the influence of wireless waves in diverting carrier pigeons.

I have, therefore, set myself to the task of experimenting with wireless and carrier pigeons, my basic idea

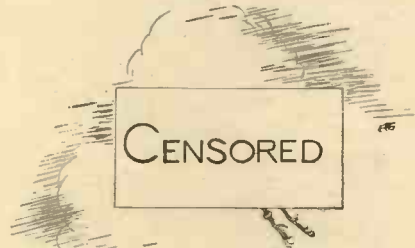

What (censored) do for a living.

being to connect the anchor wires of the (CENSORED) to a powerful wireless transmitter in order to deflect the course of the birds and prevent their crashing into them. There is at present one great snag, and that is that, although it seems scarcely credible in view of the dire urgency of this problem, I find myself unable to get the necessary permission to experiment with the anchor wires of the (CENSORED). Can any of you who have any influence with the Government use it now to help in checkmating this amazing piece of official stupidity?

Daisybell Up to Date

I HAVE just completed the installation of *The Wireless World* battery stand-by receiver for use in case of a possible temporary mains failure. I am, however, very far from happy in my mind concerning the question of electric shaving. As I recently told you, I have felt it my duty to support the electrical industry by adopting this method of shaving, but the electrical industry don't seem to have thought it their duty to support me by providing me with some means of getting a power supply for my razor should the mains fail. I can, in fact, stew in my own juice so far as they are concerned, for they are

Unbiased—

not moving a finger to supply any emergency juice for me.

I had thought at first of using an HT battery, but I find that this is quite impossible. Most of these devices take 10 watts, and are 100-volt instruments operated, in the case of 200 volts mains, in series with a suitable resistance. Now there is, unfortunately, no getting away from Ohms law, and 10 watts at 100 volts means 100 milliamperes, and no HT battery will stand up to the strain.

Fortunately, I recollected details being published in *The Wireless World* some time ago of a novel method by which power is obtained in certain parts of Africa for a transportable wireless transmitter. Two coloured gentlemen sit astride of what is virtually a bicycle made for two, without any wheels. A generator is mounted in its framework, and the pedalling efforts of the coloured gentlemen are transmitted to it.

No sooner had I thought of this idea than I sallied forth to get a bicycle made for two, but, believe me, it was a far more difficult job than you might imagine. In these days of spy-mania the very nature of my enquiry, namely a bicycle made for two, without any wheels, aroused suspicion. In the end I had to buy a pukka tandem bicycle with wheels. Having got the thing rigged up with great expenditure of time and labour, it suddenly occurred to me that I lacked the necessary two coloured gentlemen. I thought that

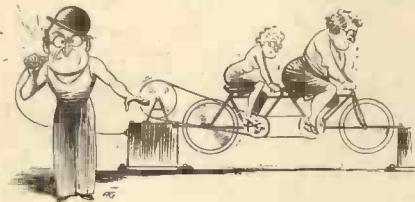

Forced labour.

after my previous experience it would sound altogether too suspicious if I made the round of the shops and labour exchanges in search of these, and I have, therefore, had to adopt press-gang methods with regard to Mrs. Free Grid and her sister, who is staying with us.

Naturally, I have been practising with the apparatus but I cannot say that at present things are going al-

together smoothly. Mrs. Free Grid seems to have absolutely no idea of smooth and even pedalling, with the result that at one moment the razor nearly stalls and at the next moment the voltage rises to a dangerously high value, causing the razor to make a noise like an aero-engine and exciting the suspicion of passers-by.

Antiphase A.R.P.

IT seems to me an extraordinary thing that in this super-scientific age in which we live, such crude and unscientific methods are being used to bring about a general black-out. Our present methods were undoubtedly employed by our cave-men ancestors as a means of protecting their dwellings from the nightly raids of the pterodactyls and similar monsters which infested the air in prehistoric times. Evidence of this was long ago discovered by an old friend of mine who occupies the chair of Palæoethnology at one of our most ancient seats of learning. He even discovered evidence of a primitive kite-barrage designed to entangle the wings of the marauding pterodactyls.

I am at present engaged in perfecting a method of tackling the black-out problem which is worthy of our present-day scientific age. Now you are probably aware of what I mean when I talk of the floodlighting of buildings. It may seem rather foolish of me to make this remark, but if this war goes on for the length of time which Mrs. Free Grid evidently anticipates, judging by her preparations, we shall eventually find ourselves faced by a distinct difficulty when our great grandchildren usurp the prerogative of a High Court Judge and ask us "What is floodlighting?"

However, at present, at any rate, we all know what floodlighting means, and let us hope that by this time next year we shall be enjoying it again. I will warrant, however, that few of you know what "flood-darkening" means, and yet it is very simple. Light consists of ether waves, differing only in length from wireless waves. Although both light and wireless waves are pressure waves, it will be convenient for the purpose of my explanations if we consider them as surface waves such

as we see at the seaside, and as are illustrated in our wireless text-books. Now if you imagine one of these text-book diagrams of a simple sine wave it will be obvious to you that if we could only start off a wave of light which was lagging or leading the original wave by 180 deg.—or to put it more simply, was 180 deg. out



Primitive kite-barrage.

of phase—we should exactly cancel the original wave, and darkness would result.

It is my problem, therefore, to discover a means of generating light waves which are exactly 180 deg. out of phase with the light of the sun or any of our artificial sources of light, and we shall then be able to cover the land with a mantle of perpetual darkness by day and by night and have done with our present primitive and trumpery black-out methods.

There is only one snag, and that is this. If light waves can be cancelled by the generation of waves 180 deg. out of phase with them, so also can wireless or even sound waves. If the enemy got hold of the idea, therefore, he could at once put the B.B.C. out of action—not a bad thing in the case of some of their efforts—but what is far more serious he could effectually silence our sirens. You will understand, therefore, that I cannot possibly publish the technical details of any discovery that I make in this matter.

Directional Reception

A "STEERABLE" SHORT-WAVE AERIAL

By CHARLES R. LEUTZ

RADIO receiver design has advanced so far during the past few years that maximum receiving range is no longer a matter of receiver sensitivity. The received signal must exceed the local noise level in strength, otherwise added receiver sensitivity cannot be used effectively.

An increase of received signal strength can invariably be obtained by using more efficient aerial arrays. An array highly effective in one direction not only gives increased strength to the desired signal, but also simultaneously eliminates interference in all the other directions.

Many of the directional doublets in use to-day are only effective in two directions. A more flexible arrangement of directional antenna control is shown in the attached drawing, Fig. 1, in which it is possible to obtain efficient reception in practically any direction desired and to exclude interference from all other directions. The system consists of four separate "V" aerials, viz., NN'E'E, EE'S'S, SS'W'W, and WW'N'N. Each elevated wire is provided with a separate lead-in, "V" type, as shown in the drawing. The lead-in wires for NN' and S'S are connected to one twisted transmission line, and the lead-in wires for WW' and E'E are connected to a second twisted transmission line. These two twisted transmission lines are, in turn, twisted together, providing a four-wire transposed transmission line with approximately equal impedance between any two wires.

As the four elevated wires of the array are 90 degrees apart, the proper length of each wire is $1\frac{1}{2}$ times the wavelength primarily desired. For example, in planning to use any one of the four "V" aerials principally for 20 metres, each elevated wire should be $1\frac{1}{2} \times 20$ metres, or 65.6 feet. Ordinarily, especially in the case of transmitting aerials, a single "V" aerial of this type is used with a $\frac{1}{4}$ -wave-

length matching stub, which, in turn, is connected to the transmission line. This last-mentioned form of aerial and lead-in, if used for reception, provides a system limited in frequency response approximating to the exact frequency for which the aerial is designed.

Therefore, in order to obtain a much wider and more efficient frequency coverage, a different method of coupling the aerial elements to the transmission line is used. This consists of a "V" lead-in for each aerial element, converging to the

transmission line as shown in Fig. 1. Each lead-in from each elevated wire to the transmission line is 10' long. Each elevated wire is tapped off 5' from the common centre, making each pair of wires about 10' apart at the lead-in point.

In addition to the four "V" aerials described, the system provides two "V" doublets, NN'S'S and WW'E'E, which may be used separately or jointly. Ordinary doublets when used with matching stubs are

also limited in frequency response. To spread the frequency response, the "V" type lead-in is used, and provides "V" doublets usable in the combinations shown in Fig. 2.

The characteristic impedance of the "V" lead-in is high at the aerial connections, corresponding to the doublet impedance. At the low end of the "V" lead-in the characteristic impedance is low, and approximates to that of the transmission line. Accordingly, an efficient match is obtained between the doublet and transmission line, resulting in smooth transfer of signal energy from the doublet to the transmission line over a wide range of frequencies. An antenna designed for 20 metres will be efficient at all har-

monics of that frequency; and with the special lead-in arrangement very satisfactory reception is obtainable over a wide range of intermediate frequencies.

THE range and reliability of short-wave broadcasting have been greatly extended by directional transmission; the application of similar principles to reception gives in many circumstances an appreciable improvement in signal/noise ratio.

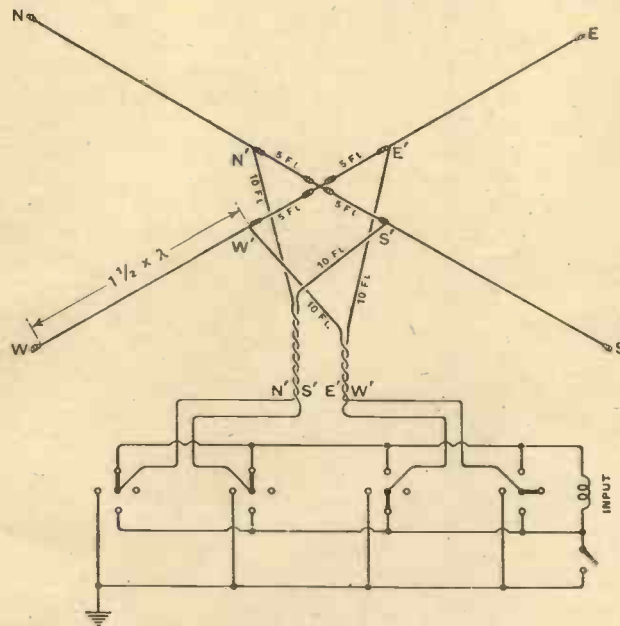

Fig. 1.—General arrangement of the aerial described, with connections of the direction-selecting switching system. The two twisted transmission lines are shown separate for clearness, but are actually twisted together.

Directional Reception—

At the receiver end the transmission lines are connected to four single-pole, four-way switches as shown in Fig. 1. This switch control panel permits the selection of any one of the 16 "V" doublet or aerial arrangements, as shown in Fig. 2. In addition, the unused elevated aerial elements may be either grounded or left "floating" free for possible parasitic reflector effects, for either increasing signal strength or eliminating interference. A single-pole single-throw switch allows the earthing of one side of the doublet input coil to allow using any or all aerial wires as an ordinarily non-directional collector.

Employing Directional Properties

This flexible aerial arrangement is a valuable addition to any DX receiving station. For example, when a desired signal is first detected, adjustment of the aerial

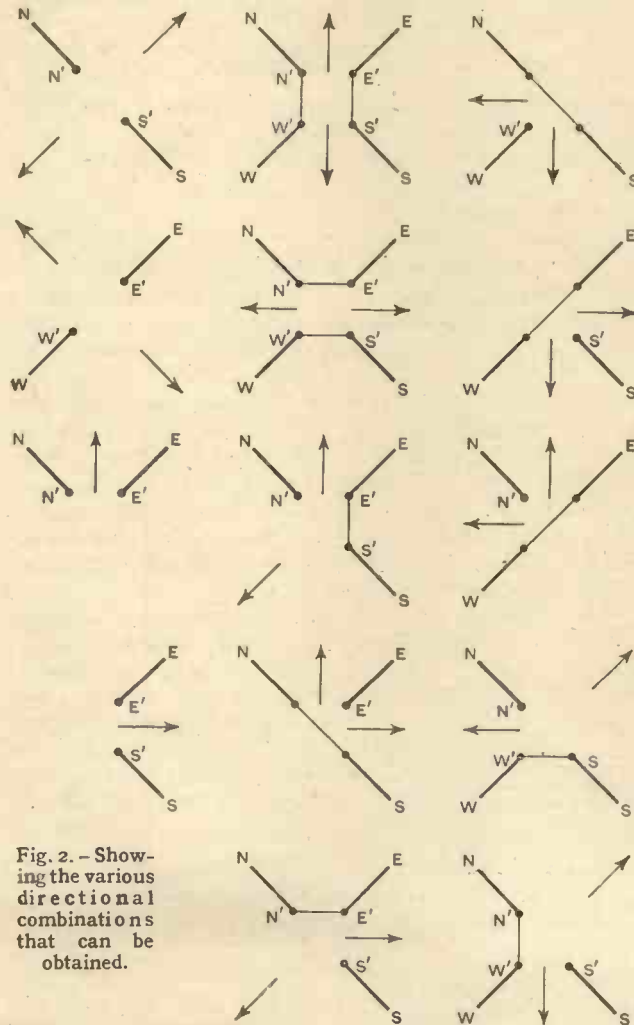

Fig. 2. — Showing the various directional combinations that can be obtained.

control switches will invariably give an immediate increase of signal strength which in turn allows the receiver to be more easily tuned. In a similar manner, manipulation of the switches alone will often eliminate

interference that otherwise could not be accomplished with the receiver alone.

Some receiving stations may be so geographically located that reception from a few certain directions is the most important consideration. Fig. 3 shows a system consisting of three adjacent "V" aeri-

als, which with the switching arrangement will provide reception from five principal directions. In this example the elements are separated 50 degrees and accordingly the elevated wires should each be four times the principal wavelength. Where space is limited, the separation can be made 65 degrees, in which case each wire should be three times the principal wavelength in length. In all cases the same converging "V" lead-in arrangement is used, the lead-in dimensions being as shown in Fig. 1.

The transmission line itself should be good quality rubber-covered copper wire. A twisted pair of No. 14 SWG rubber-covered wires varies in impedance between about 65 to 170 ohms. The receiver input inductance should, of course, match the transmission line.

"The Trader Year Book"

IT is announced by *The Wireless and Electrical Trader* that the state of war, which is producing all kinds of changes in factory production, addresses of suppliers, and so on, makes it impossible to produce an up-to-date directory for radio and electrical trades in time for the autumn and winter season; and for that reason publication of the 1940 edition of "The Trader Year Book" (which would have taken place in October) has been cancelled.

A number of the Year Book reference features will be incorporated in the weekly issues of *The Wireless and Electrical Trader* as opportunities present themselves.

INDEX AND BINDING CASE

THIS, our first monthly issue, starts a new volume of *The Wireless World*: The index for Volume XLV, July 6th to September 28th, 1939, will shortly be available from the Publishers, Dorset House, Stamford Street, London, S.E. 1, price 4d., post free, or with binding case, price 3s. 1d., post free.

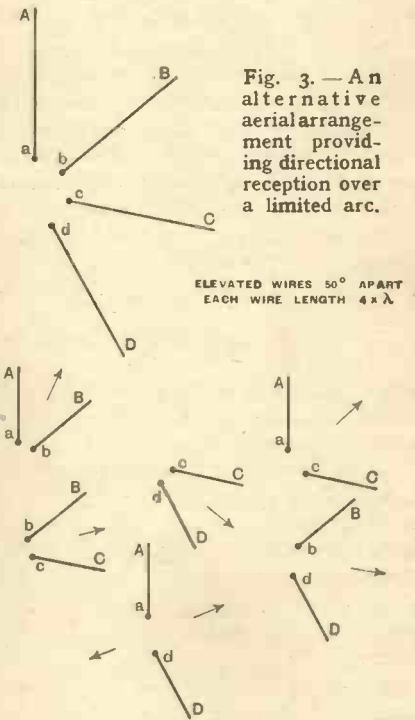

Fig. 3. — An alternative aerial arrangement providing directional reception over a limited arc.

Letters to the Editor

THE EDITOR DOES NOT NECESSARILY ENDORSE THE OPINIONS OF HIS CORRESPONDENTS

An Appreciation

IT is reassuring news that we are not to be deprived of our mental pabulum, although we are to have our rations monthly instead of weekly in future.

For many readers the perusal of *The Wireless World* is one of the few remaining links with normality, and so the cessation of its publication is unthinkable. I, for one, shall continue to purchase it regularly until taxation and other imposts rise to 20s. in the pound!

Torquay, Devon. DONALD W. ALDOUS.

Lessons from the Last War

I READ with great interest your Leader on "Wireless Personnel and the War" in your September 21st issue, as I was without doubt one of the insufficiently trained men of the last war to whom you refer. The cap fits me exactly.

After a few weeks' study at a wireless school, in which I had no practice whatsoever in the actual reception of wireless signals, I went before the G.P.O. examiner and duly obtained a First-class P.M.G. certificate. Four days later I was appointed sole operator on a large cargo steamer which had just been fitted with wireless for the first time, and which sailed almost immediately for the Mediterranean.

I was still in the position of never having heard an actual wireless signal in my life, and I well recollect my dismay when the captain intimated to me that he would expect to have on his breakfast table a complete copy of the Press bulletin which was sent out nightly by Poldhu. At that time Poldhu was merely a name to me, and, in addition to my ignorance concerning his call-sign, I was unaware of either his wavelength or the hour at which he sent out his Press bulletin. Unfortunately, as the ship was newly fitted with wireless, I could gain no help by referring to the wireless log book of the preceding voyage, but, happily, by a diligent search among the "literature" supplied to me, I discovered these very necessary facts.

I was now confronted with a further difficulty. Whereabouts on the giant "reel of cotton" receiving inductance was 2,750 metres, and what would Poldhu's signals sound like if I were fortunate enough to hear them? Would they be overwhelmingly loud, like the artificial practice signals I had been accustomed to at the wireless school, or should I have to strain my ears to catch them? And how was I to adjust the crystal, as I had never handled one before, having been trained on a magnetic detector? Would Poldhu send far too rapidly for me to cope with in my present nervous condition, thus leaving me to face the wrath to come at the captain's breakfast table in the morning?

I shall never forget the sense of relief—to say nothing of the thrill—I experienced that night when I managed to pick up the clear and long-drawn-out CQ call sent out by MPD. I very soon had my receiver adjusted to maximum efficiency, with the result that in the morning

the captain looked upon me as a hardened and experienced operator; at least, he probably would have done had I not had the misfortune to be violently sea-sick at the breakfast table. "SPARKS."

Wireless Thrills

YOUR contributor "Diallist," writing in a recent issue, implies that the biggest thrill he has had out of wireless was the hearing of transatlantic broadcasting. The early short-wave telephony transmissions from KDKA did, I suppose, mark a definite stage in wireless development for many of us, but I personally found the greatest "kick" from my first triode valve receiver.

That set, built in 1919, was a crude single-valve affair consisting of a regenerative detector with plug-in coils. But its range, as compared with the magnetic and crystal detectors and Fleming diodes to which I had been accustomed, was truly phenomenal. The whole world of wireless seemed to be at one's finger-tips, and it was hard to believe then that anything very much better could ever be devised. "RADIOPHARE."

Musician's Lament

THE abrupt cessation of the Promenade concerts and the immediate prospects of facing the winter evenings with nothing but cinema organ and "restaurant" music is somewhat chilling to those of us who turn instinctively to the great works for spiritual sustenance in times like these.

If we cannot get enough of the real thing from the B.B.C., we must overhaul and replenish our stock of gramophone records and try to reconstruct for ourselves something of the atmosphere of "pre-war" concert-hall broadcasts. We have the requisite high-quality amplifiers and loud speakers, but where are we to look for a really first-class pick-up of straight-line characteristic and low amplitude distortion?

If we cannot trade with the enemy, and the nearest British equivalent is obtainable only by buying a complete radio gramophone, there should be a just reward awaiting the manufacturers who will produce a needle armature, moving coil, or ribbon pick-up of such design at a reasonable price. "EUTERPE."

[Our correspondent appears to have overlooked the possibilities of piezo pick-ups of the better class.—ED.]

Deaf Aid Adaptor

IN your issue dated September 28th, page 288, a very extensive article is published describing a Deaf Aid Adaptor.

This article might give the impression that the idea is a new one, and we feel, therefore, that you may be interested to know that we have regularly marketed practically identical equipment for the last three or four years under the trade name "Radiodente."

Ardente Acoustic Laboratories, Ltd.

London, W.1.

H. P. J. HART.

Valve-operated Smoothing Circuit

BALANCING OUT HUM

DESCRIBING an arrangement in which changes of potential that would normally produce hum are balanced out by the action of a triode valve. The method is largely independent of frequency.

IT is now almost universal to employ a combination of chokes and condensers for smoothing—to use, in fact, a form of low-pass filter. Chokes in series with the HT supply and condensers shunted across it form a very satisfactory filter, for they provide adequate smoothing for most purposes and are reasonably cheap. Even for high-quality apparatus two chokes and three condensers arranged as in

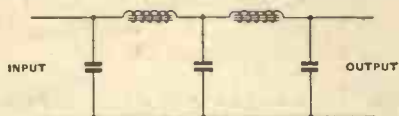

Fig. 1. Conventional two-stage smoothing circuit as used with high-quality amplifiers of moderate gain.

Fig. 1 prove adequate with a normal AF amplifier of only moderate gain.

It has often been suggested in the past that the smoothing could be greatly increased by tuning one of the chokes by means of a shunt condenser C (Fig. 2). The greater smoothing would then enable the filter to be used with a higher gain amplifier, or else it would permit a reduction in the size of the chokes and condensers.

Hum Frequency

In practice, however, this scheme is not very useful. While it can occasionally be adopted, it fails for general use because mains hum does not consist of a single frequency. With the usual full-wave rectification the ripple has a principle frequency of twice the mains frequency, or 100 c/s in most cases. There are appreciable components of higher frequency, however, which can be important since the ear is more sensitive to them.

By adjusting C in Fig. 2 so that LC resonates at 100 c/s, a very large

reduction of hum of this frequency can be secured, but the presence of C causes an increase in hum of other higher frequencies. If the hum in the output of an amplifier is measured by a meter which does not discriminate between different frequencies, it is quite easy to adjust C so that a big reduction of hum is indicated. When a listening test is adopted, however, it is not uncommon to find that the audible hum is greater than before, but of higher frequency. A low-pitched hum has been turned into a high-pitched one of apparently greater intensity.

The total hum has been decreased, as indicated by the meter, but the high-pitched hum has been increased, and as the ear and loud speaker are more sensitive to it the



Fig. 2. The artifice of tuning one of the smoothing chokes to resonate at the predominant hum frequency does not always work out satisfactorily in practice.

net result is a deterioration of performance. Because of this the circuit is but little used, and it is usual to adopt the arrangement of Fig. 1. In the case of very high gain amplifiers, such as microphone amplifiers, it is not always easy to get sufficient smoothing. In such cases considerable interest attaches to a special balancing circuit which is largely independent



of frequency and which will theoretically reduce hum to zero.

The arrangement is shown in Fig. 3 and it will be seen that a valve, a condenser, and three resistances are used to replace the output condenser of the filter.¹ Assuming linear valve characteristics and that the reactance of C is very small compared with the resistance of R₃ at the lowest important frequency, the hum output is zero when the circuit is correctly balanced.

Valve Action

What happens is this. When the ripple causes a momentary rise of anode voltage this change of voltage is also communicated to the grid of the valve through C, causing the grid to become less negative. This increases the anode current and the anode voltage falls owing to the increase of current through the resist-

¹ *Electronics*, June 1937.

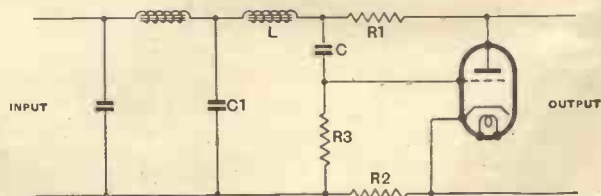

Fig. 3. The balancing circuit of which the operation is described in this article.

Valve Operated Smoothing Circuit—
ances. When the circuit is balanced the fall of anode voltage due to the change of grid potential is just equal to the rise due to the ripple on the supply and no change of anode voltage results. In other words, the change has been completely smoothed out.

The condition for balance is that the sum of R_1 and R_2 ohms should equal the reciprocal of the mutual conductance of the valve in amperes per volt ($R_1 \times R_2 = 1/g$). R_2 is to provide bias for the valve and its value depends on the bias needed and the total current taken from the supply.

Suppose the total current, including that taken by the smoothing valve, is 50 mA. and 3 volts bias is needed, while the valve has a mutual conductance of 3 mA/V. Then $R_2 = 3/0.05 = 60$ ohms, $R_1 + R_2 = 1,000/3 = 333$ ohms, and $R_1 = 333 - 60 = 273$ ohms. The total resistance of the HT supply is increased by $R_1 + R_2$ and in this case there will be a loss of voltage of $333 \times 0.05 = 16.65$ volts.

In practice R_1 should be made variable so that an exact balance can be secured, and to suit the above example a component with a maximum value of some 500-600 ohms would be suitable. It is also necessary to take care that the valve is not overloaded by the ripple, otherwise it will introduce harmonics of the predominant ripple frequency and be open to the same drawbacks as the circuit of Fig. 2. There is probably little risk of this if a stage of normal smoothing is used preceding it, as shown in Fig. 3.

The values of C and R_3 are not critical. R_3 should be as high as possible and 0.5 megohm is a suitable value; C must be large enough in relation to R_3 to cause negligible phase shift at the lowest hum frequency. A value of $1 \mu F$ is quite good.

The choice of valve is not difficult. It should have a high mutual conductance in order to keep $R_1 + R_2$ low, a low anode current for economy, and a long grid base so that it can handle a large ripple voltage without distortion. Some of these requirements are conflicting, but if care is taken not to apply too much ripple to the valve a small AF

triode is suitable. A valve of the MH4 class will usually be satisfactory.

Another advantage of the system is that the output impedance is resistive and nearly equal to $1/g$; when $g = 3$ mA/V. the impedance is about 333 ohms. This holds at all frequencies for which the reactance of C is very small compared with R_3 and provided that the shunting effect of the preceding components, such as L and C_r , is negligible. In practice, this usually means that the output impedance is substantially constant for frequencies higher than a certain low frequency which is normally well below the mains frequency.

The output impedance is not maintained constant down to zero frequency, so that for television purposes the circuit offers little advantage in this respect over the conventional one. It can give better smoothing, however. Its greatest application probably lies in microphone amplifiers and laboratory equipment where the attainment of a minimum of hum is an essential requirement.

Emergency Power Plants

FROM enquiries which we have received it would appear that there is still a steady demand for petrol-electric generating sets for battery charging and stand-by lighting. Readers who are interested may be glad to know that Leslie Dixon and Co., 218, Upper Thames Street, London, E.C.4, have a stock of reconditioned generators suitable for this purpose.

We have recently inspected some of these plants, and they appear to be in excellent condition and are of unusually robust design. The engines are Stuart two-strokes, and in the Type No. 16 (150 watt) sets are fitted with a trip ignition cut-out to prevent racing on open circuit. In the Type 52 (500 watt) sets a totally enclosed governor, which can be adjusted while running, controls the engine speed. The engines are comparatively slow running, the nominal speed being in the region of 1,000 r.p.m.

The output of the 150 watt generator is 25-37 volts at 6-4 amps, and of the 500 watt type, 50-70 volts at 10-7 amps. The prices are £12 and £16 respectively.



"Nowadays," said that knowing chap Hughes,

"One can't risk ever missing the news.

So to keep my new set

'On the job, you can bet—

For the wiring it's FLUXITE I choose!"

See that FLUXITE is always by you—in the house—garage—workshop—wherever speedy soldering is needed. Used for 30 years in government works and by leading engineers and manufacturers. Of Ironmongers—in tins, 4d., 8d., 1/4 and 2/8.

Ask to see the FLUXITE SMALL-SPACE SOLDERING SET—compact but substantial—complete with full instructions, 7/6.

Write for Free Book on the art of "soft" soldering and ask for Leaflet on CASE-HARDENING STEEL and TEMPERING TOOLS with FLUXITE.

TO CYCLISTS! Your wheels will NOT keep round and true, unless the spokes are tied with fine wire at the crossings AND SOLDERED. This makes a much stronger wheel. It's simple—with FLUXITE—but IMPORTANT.

THE FLUXITE GUN

is always ready to put Fluxite on the soldering job instantly. A little pressure places the right quantity on the right spot and one charging lasts for ages. Price 1/6, or filled 2/6.



ALL MECHANICS WILL HAVE

FLUXITE

IT SIMPLIFIES ALL SOLDERING

FLUXITE LTD. (Dept. W.W.),
DRAGON WORKS, BERMONDSEY,
STREET, S.E.1.

Pilot "Twin Miracle" Portable

PORTABLE SUPERHET FOR BATTERY, AC OR DC MAINS
OPERATION (FOUR VALVES AND RECTIFIER). Price 10 Gns.

THE best points of the two main categories of portables—battery operated sets for outdoors and AC/DC transportables for room-to-room use indoors—have been amalgamated in this ingenious receiver.

Basically it is a four-valve superheterodyne with 1.4 volt valves working off a combined HT and LT dry battery. Alternatively, it may be run off either AC or DC mains through a separate rectifier and smoothing circuits. There need be no fear of accidental misapplication of one or both sources of power, for a relay is fitted which automatically switches off the batteries and adapts the circuit for mains operation when the set is plugged into a domestic supply socket. Should the mains fail or the plug be inadvertently pulled out, the relay will automatically restore the battery circuit and the programme will continue without interruption.

WAVERANGES

Medium .. 200-560 Metres
Long .. 1,000-2,000 Metres

Circuit.—The frequency-changer, which is of the pentagrid type, is followed by a single IF stage with iron-cored coupling transformers. A single-diode-triode valve rectifies and amplifies the signal and provides AVC for the frequency-changer and IF stages. It is followed by a pentode output valve which feeds the moving-coil loud speaker.

From a technical point of view the chief interest lies in the power supply circuits. With the relay in the "battery" position everything is straightforward: the valve filaments are connected in parallel and bias for the output stage is derived from a resistance between -LT and -HT. The relay is energised by rectified

and smoothed filament current which in the first instance passes via the bottom pair of contacts to the pilot lamp. When the current reaches a predetermined value the relay armature is pulled up and the HT and LT circuits are simultaneously transferred from batteries to the mains. The valve filaments are at the same time connected in series-parallel. Starting from the relay winding the current of 0.1 amp., which has been standardised for the filament circuit, passes first through the output valve filament and then divides through the IF and second detector valves, both of which are 0.05 amp. valves. The frequency-changer, which has a similar filament rating, is shunted by a resistance of equal value to by-pass half the standard current, which then returns via the pilot lamp to the rectifier anodes.

The main HT resistance consists of the external line cord to the mains plug, and a separate vitreous en-

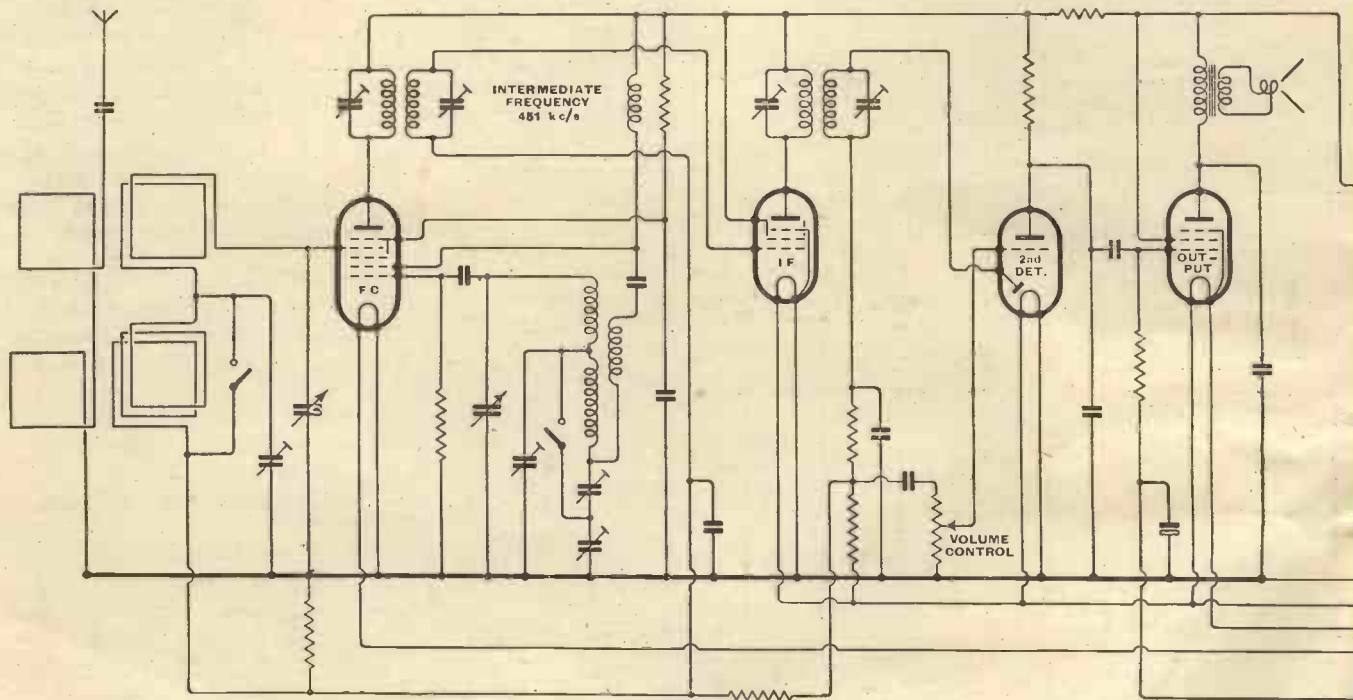

amelled resistance inside the set breaks down the filament voltage to the required value. Grid bias is derived from a network between the common HT negative and chassis, and due allowance is made for the fact that the output valve filament is above chassis potential. Condensers totalling 80 mfd. are used for smoothing, and all bias circuits are as liberally by-passed.

Performance.—

The first tests were directed to proving the reliability of the

Front and back views showing controls and layout of valves. The front lid pulls down over tuning dial and loud speaker for transport.

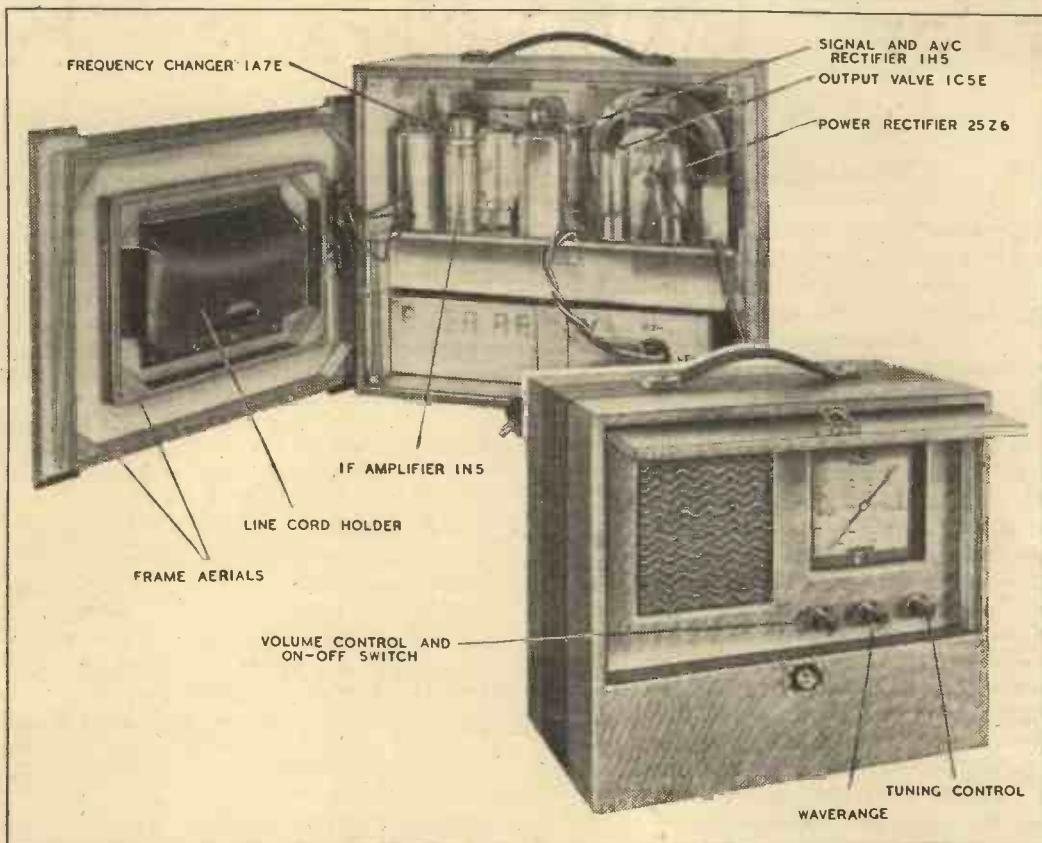

relay and every sort of carelessness and abuse was tried in an effort to make it miss a beat. The only type

of mains failure which seems capable of interrupting the programme is a break of between two and three seconds in the supply. Under these conditions the relay still works perfectly, and there is no question of any damage to the smoothing circuits or batteries, but the rectifier is caught in a half-warmed condition, and until it regains its working temperature the balance of current in filament, HT and bias circuits is disturbed and the set momentarily ceases to function.

We mention this only as a matter of interest, for mains interruptions of such short duration are rare. In all other circumstances the

change-over works perfectly with a faint click as the relay contacts go over. Switching on from cold, the set starts to work immediately from the batteries, and the change-over to mains (if the set is connected to a power point) occurs after about 30 seconds on AC and 50 seconds on DC.

With new batteries there is little difference to be noted in signal strength or quality when the set changes itself over from mains to batteries or vice versa. Deterioration of the batteries will be notified in good time by the comparison of performance which is automatically given every time the set is used on the mains.

The maximum rating of the output valve (200 mW.) is reached by most of the long-wave stations and about five Continental stations under daylight conditions. This level can, of course, be exceeded on the more powerful stations, but if it is kept within the specified limits by the volume control, quality is very good when judged by portable set standards.

The intrinsic selectivity of the cir-

Circuit diagram of the Pilot "Twin Miracle." The relay contacts are shown in the "battery" position. On mains the filaments are heated by rectified and smoothed current.

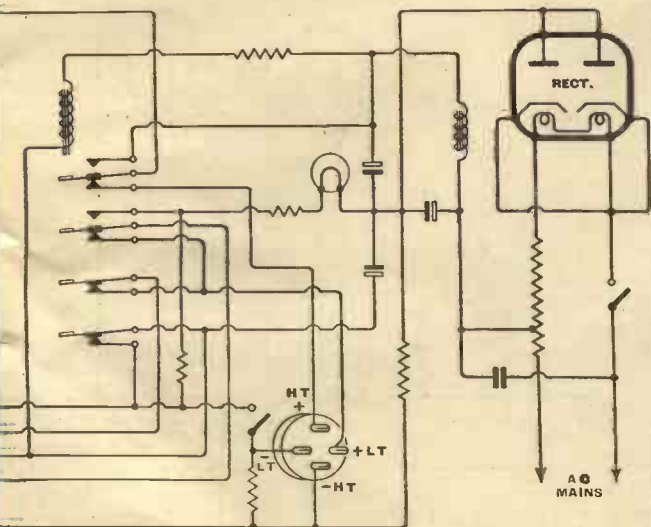

Wireless World

Pilot "Twin Miracle" Portable—cuit is equivalent to the loss of about two channels on the local station, but the frame aerials show marked directional properties which can often be used to remove the last traces of interference from stations in adjacent channels.

Constructional Details.—The line cord resistance is 14 feet in length. For obvious reasons this must not be shortened, so the makers have provided a neat recess in the back of the set with a snap-fastened lid to house the cord when not in use.

The battery, which is housed low down in the cabinet, is of the combined HT and LT type, and a single 4-pin plug makes the necessary connections. It is rated to give a useful life of 200-240 hours, and the capacities are proportioned, so that the two sections run down together.

Two indicators are provided in the tuning dial. The lower one is of the shutter type and shows a red disc when the set is switched on. At the top of the scale is another aperture through which the pilot light is viewed. This lamp does not glow until rectified current is actually flowing in the filament circuit, and its primary function is to show whether the set has been connected with the right polarity when working off DC mains. Otherwise the set might go on working for months off the battery circuit while the mains were uselessly heating only the rectifier filament.

Summary.—The "Twin Miracle" receiver fully deserves the title of "universal" which has hitherto been appropriated with less justification by AC/DC sets. Economical as a battery set, it is even less expensive to run from mains, and will work for 12 hours on a unit of electricity. On the score of performance it is well up to the standard set by portables employing the latest 1.4 volt valves.

Operators for the Merchant Navy

THE Glasgow Wireless College, which specialises in training students as Radio Officers for the marine service, has just issued a new prospectus. Copies are obtainable from the Principal at 3, Park Gardens, Charing Cross, Glasgow. The associated Dundee

Wireless College, Crescent House, 40, Windsor Street, Dundee, has produced a similar brochure.

Osram Peak Voltmeter Diode

A SMALL directly-heated diode has recently been introduced by the General Electric Co., Ltd., for use in direct reading peak voltmeters. It is known as the Osram Type A 373 and is suitable for frequencies up to 300 Mc/s. For inputs above 100 volts and frequencies below 100 Mc/s readings are accurate to within a few per cent. Outside these limits calibration is necessary. The filament may be heated from a 2-volt accumulator and takes 1.6 amp at 1.8 volts. The total emission is 3 mA. and the anode-filament capacity is 0.5 micro-mfd. The valve is 16 mm. in diameter and 70 mm. overall in length. It is fitted with a standard S.E.S. screw base and top anode cap. The price is £3.

"Rotaceptors"

EFFICIENT CONVERSION OF DC TO AC

THE machines marketed under the above name were developed originally for operating neon signs from batteries. The principle of operation is a synchronous rotary interruptor in conjunction with a transformer, special attention having been given in the design to the attainment of constant speed and hence of frequency. Recently the principle has been modified to give improved waveform and an output which is a close approximation to normal 230-240-volt AC supplies.

The "Rotaceptor" machines, while possessing the reliability of armature-wound commutator machines, are far less bulky. The rotor is either a laminated or cast-iron flywheel running on oil bearings. A commutator on the same spindle operates in conjunction with brushes housed in the aluminium outer casing. The brushes can be removed for inspection or replacement from the outside. There are no windings on the rotor and the field is generated by a single coil wound on a two-pole laminated core.

The motor speed is controlled by the position of the com-

mutator relative to the rotor poles, and is fixed to give 50 cycles in the machines mentioned below. For other purposes frequencies from 25 to 500 cycles may be provided.

Waveform is also under control and is determined by the use of small high-capacity reversible electrolytic condensers connected in parallel with the primary winding of the step-up transformer and the motor field winding. At each interruption of the direct current the discharge of the condenser, together with the collapse of the magnetic field in the rotor, completes a full-wave cycle in the primary AC circuit.

This feature of the design also ensures correct commutation and the elimination of sparking at the brushes. Furthermore, any appreciable DC component is prevented from flowing in the transformer primary winding. It is claimed that efficiencies as high as 83 per cent. have been obtained.

The G-type "Rotaceptors" for use with 6- or 12-volt accumulators are as follows:—

	Voltages		Max. Wattage	Price
	DC Input	AC Output		
G. 6/60	6	230/240	60	£6 0 0
G. 12/60	12	230/240	60	£8 0 0
G. 6/100	6	230/240	100	£7 10 0
G. 12/100	12	230/240	100	£7 10 0

The weight of these machines is only 6½ lb., and the dimensions 5½ in. by 5 in. by 7 in. Enquiries should be addressed to Technical Inventions, Ltd., Terminal House, Grosvenor Gardens, London, S.W.1.



Random Radiations

By "DIALLIST"

Irony of Fate

IN the glad times of peace there was one thing in particular that was not my long suit. Oft did I hear and read thrilling tales of marvellous DX on both medium and short waves by those who, by leaping from them or otherwise, left their beds at hours such as 04.00 or 05.00 and sat them down to their receivers. But early rising was a thing that left me both metaphorically and literally cold. Though I longed to join the other early birds in their successful hunt for the radio equivalent of worms; though I resolved that one of those mornings I would arise and fill my log to bursting point, it was not to be. Sometimes I got so far as setting an alarm clock for some horrible hour; but when it aroused me the only result was that I said things about it that would probably have shocked the pious Swiss who made it, and turned over to the other side. So much for peacetime. Now my faithful batman calls me several times a week at 03.15. He has strict orders not to depart until he has seen me not merely conscious but afoot. Seeing the dawn break has become a familiar experience, and, despite what poets and others have written on the subject, dawn-seeing is, I feel, a singularly over-rated pastime.

To No DX Purpose

The worst of it is that now that I have to be up so often at these grisly hours I can turn them to no good radio purpose. I do not hear the medium-wave Americans at their best; not for me is it to tune in mighty voices from Australia. Had I a wireless set in action that would do the job I might steal a few minutes now and then for some profitable work with the knobs—if the knobs were of the kind that could profitably be twiddled. But they aren't. They belong only to a small and none too efficient battery set with no short-wave range. Meantime, to mock me, there reposes in a box beneath my bed a really good receiver, whose performance on the medium and the short waves would be fine if only it had a chance to perform. It hasn't, because, as I've mentioned before, it requires AC at 200 volts or more and all that is available at my present address, somewhere in England, are 50 miser-

able volts DC. There is, however, hope of better things. My batman (batmen usually know these things even before Colonels) tells me that we shall shortly move to another station. I hope he is right—though if some previous news of his had been correct we should be some thousands of miles from here by now—for that other station I have ascertained has a glorious mains supply of 230 whole volts AC.

The Mega-micro Age

THIS is indeed the age of mighty things, and of astronomical figures. And the very big and the very small have this much in common, that with both vast arrays of figures occur. Looked at in one way 10^{18} and 10^{-18} are both huge things. And the wireless valve, in partnership sometimes with the photo-electric cell, sometimes with the cathode-ray tube, has been responsible for not a few of the Megas and the Micros of modern knowledge. One of their most amazing achievements is the electron microscope, which has enabled magnifications believed only a few years ago to be utterly impossible of accomplishment. In books written not so many years ago you will find such statements as "No one has ever seen an atom and it is most unlikely that anyone ever will." Would you say that now? Already the electron microscope has made visible objects little bigger than some molecules. It doesn't seem at all outside the bounds of possibility now that one day it will enable us to see not only molecules, but also the atoms that compose them. Will electron-optics be applied in some way to the telescope also one day, enabling us to amplify the light that comes to us from bodies far away in the very depths of space? One thing is sure: the valve and the vacuum tube have even more wonders in store for us than they have provided already.

Tempora Mutantur

SO *The Wireless World*, after years as the most welcome of weeklies, becomes a monthly magazine. Those of us who have looked for it towards the end of each week—Thursdays for some time now, though it used to be Fridays—will feel that there's some-



EVERYTHING FOR RADIO

Present conditions make Radio more vital than ever to Life; it has become a National necessity. You must keep your set in fighting trim for the Home Front. Modernisation and construction with Bulgin Products ensures satisfaction. And you can get all you want from our unparalleled range.

RESISTORS

The Bulgin range of resistors, always large and comprehensive, now includes over 225 added types, to meet every need. Values of resistors in the Bulgin range cover from 0.5Ω to 5MΩ. Wattage factors range from 0.25 W. to 100 W. Wirewound and metalised types are available, and prices range



from 4½d. to 6/6 each. Wirewound types employ only the finest and most corrosion-proof nickel-alloy wires. Catalogue 162, page 59 onward.



BULGIN

FUSES

All Bulgin Fuses are made to B.S.S. 646 and R.C.M.F./R.M.A. Standards colour-coded and glass enclosed with plated end caps. Safe, sure, and absolutely fireproof, blow at 75 per cent. overload. Suitable for all Standard holders. Buy Bulgin and be safe. 4½d. each.

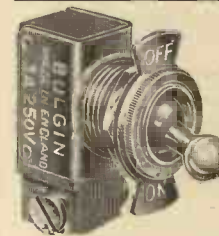

SWITCHES

The famous Bulgin Toggle Switches constitute the largest range in the industry (illustrated). List No. 5.89 Polished Nickel Plated finish, Max. 250 V. 3 A. Complete with on-off Plate. Note Large Terminals. 1/9 each. Bulgin for Switches.

BULBS

The Bulgin range of Pilot Bulbs covers M.E.S. cap and M.B.C. lamps, tubular and round, in voltages 2-14, 0.06 to 0.5 A. Every replacement requirement is met. 9d. each. (Catalogue 162, page 13.) Fit your customers' torches and flash lamps with Bulgin Low-Consumption Bulbs, 2, 4 or 6 V., .06 A. Batteries last 3 to 5 times as long (or give 3 to 5 times the burning hours), and adequate light is obtained.



RADIO SERVICE MANUAL

Servicing and Modernising Radio Receivers is easy with this New Manual, with its 280 pictorial and theoretical diagrams, and clear, concise, specialised text. Solves your problems. Price 1/6 post free.

SEND COUPON NOW

Please send me the NEW 128 pp. Catalogue No. 162, showing full range of Bulgin Products, for which I enclose 3d. stamps.

NAME.....

ADDRESS.....

W.W. 20.10.39.....

Advert. of A. F. Bulgin & Co., Ltd., Abbey Road, Barking, Essex. Tel. RIPpleway 3474 (3 lines).

Random Radiations—

thing missing till we get used to the new order of things. Still there are consolations. *The Wireless World* in its new form provides a fine fat wad of reading matter; and the great thing is that the grand old paper—by far the oldest of the wireless periodicals—still keeps going. *The Wireless World* has a wealth of fine tradition behind it and there's something rather fine about its carrying on in the present more than difficult circumstances. I hope you'll realise that it's one of the radio institutions of this country. It has done more than any other paper to keep its readers informed of the progress of wireless and to keep the radio industry up to the mark. There's little doubt that but for the work and the influence of *The Wireless World*, which has taken very strong lines at times, many of the needs of radio enthusiasts would not have been met so fully as they have been. It's of real importance to all of us that it should be able to continue so long as the war lasts as a monthly. Therefore, support the paper that has so long and so well supported your interests by placing an order for it to be delivered or kept for you each month.

Still Growing

DESPITE all the upsets, alarms and disturbances of past weeks, the number of radio licence holders continues to grow. The wireless set, in fact, has become a necessity in these days, and I suppose that it won't be long before every household that can manage to afford it will have one. Judging by the latest total we can't now be far from that state of affairs. The war has helped those who were still cogitating about installing receivers by more or less making up their minds for them. Probably there'll be other increases month by month for a short time as the last waverers come into the fold; then we shall find that we have just about reached that saturation point about which people have written and talked for so long. Curious how utterly wrong the people were who prophesied years ago that the number of receiving licences would never greatly exceed five million. Basing their calculations on a total of some 12,000,000 British homes, they worked out that much less than half of these would be able to buy and to run wireless sets. They didn't foresee the big reductions that there would be in both initial costs and running expenses. Nor, probably, had they any idea of the part that hire-purchase would play in

enabling great numbers of folk to buy by instalments sets for which they couldn't possibly have paid cash down. But perhaps the greatest miscalculation of all was concerned with the rôle that the wireless set would play in national life. Early forecasters always assumed that it would remain something of a luxury. None of them had the imagination to foresee the receiver as the virtual necessity that it has become to-day.

Fewer Thrills

IT'S interesting to notice that since the last war the Army people have largely learnt the lesson that in wireless and other electrical gear beauty is often but skin deep, and that what really matters is that it should be thoroughly serviceable under the roughest conditions and easily repaired by the replacement of defective parts with spares when anything goes amiss. During the Great War a certain gun sight that my battery was using had to be adapted for night firing. To do so it was necessary to illuminate faintly the cross-lines of its telescope. There was an aperture in the sight designed to take a small lamp and what you and I would have done would have been to use an ordinary flash-lamp bulb in a simple holder, with a flash-lamp battery to supply the current; total cost, a shilling or two. I made up such a gadget, but it was frowned upon by the big-wigs, though it worked well enough and both bulbs and batteries could be replaced by a visit to a small shop anywhere. We were bidden to await the authorised outfit. After long delays it arrived. A beautiful polished mahogany box housed a quartet of large dry cells. At one end was a little door, beneath which was an expensive switch, capable of dealing with many amperes, and a pair of huge brass terminals turned from solid chunks of metal. Another box, equally beautiful, contained a gigantic rheostat of laboratory quality that must have cost several pounds. The bulbs were of the small bayonet-cap variety, and when their filaments broke (as they did very quickly under the shock of discharge when we were in action) they could be replaced only by indenting on Ordnance for further supplies. I'm glad that the apparatus supplied today is of a much more utilitarian and less æsthetic character. The wireless amateur is to no small extent responsible, for he created a demand that produced apparatus and small parts designed strictly for the functions they were to perform.

The Wireless Industry

TAYLOR ELECTRICAL INSTRUMENTS, LTD., 45, Fouberts Place, Regent Street, London, W.1, announce that they will continue to produce their full range of meters and instruments. While present stocks last there will be no increase in price, but when production for replacement begins the increase in the cost of materials may call for a revision of the existing price list.

The Condenser Department of the Telephone Manufacturing Co., Ltd., has moved to Sevenoaks Way, St. Mary Cray, Orpington, Kent.

The Copper Development Association, Thames House, Millbank, London, S.W.1, are continuing their service to users of copper and copper alloys, and enquiries for information should until further notice be sent to the above address.

The Telegraph Condenser Co., Ltd., notify an increase of 15 per cent. in the price of mica condensers, and 10 per cent. on all other types in their lists.

Vortexion, Ltd., 182, The Broadway, Wimbledon, London, S.W.19, have just issued a new catalogue of high-grade amplifiers and public address equipment. Separate leaflets give technical details of each amplifier, and the complete folder will be sent free of charge to enquirers.

The Murphy News, which is issued fortnightly by Murphy Radio, Ltd., of Welwyn Garden City, is to carry on for the duration of the war under the title of *The Wartime Murphy News*. An interesting article is published in the current issue entitled "The News Value of Short Waves."

The General Electric Co., Ltd., announce that the list prices of their radio receivers have been advanced by amounts averaging approximately 10 per cent. The new 10-valve superhet receivers will remain unchanged in price, the table model 4010 being listed at 29 guineas, and the model 4018 auto-radiogram at 50 guineas.

W. Andrew Bryce and Co., Ltd., manufacturers of mains transformers, chokes, battery chargers, etc., have now moved to Shenley Road, Boreham Wood, Herts, in association with Furzehill Laboratories, Ltd. The latter firm will, however, retain its own identity and continue to supply signal generators, beat oscillators, and other special test instruments.

Voigt Diaphragm Replacements

THE latest light-coil twin diaphragm for the Voigt loud speaker is now available separately for fitting to existing units sold since 1929. The price of the new diaphragm is £3 17s. 6d.,

Wireless World

and this includes a liner for the magnet gap and a corrector to modify the response for best results from normal B.B.C. transmissions. An allowance is made for the old diaphragm frame and for the original speech coil choke.

Full instructions for fitting are sent out with each diaphragm, a description of which appeared in the March 9th, 1939, issue of this journal.

Club News

Edgware Short Wave Society

Headquarters: Constitutional Club, Edgware, Middlesex.

Meetings: Wednesdays, at 8 p.m.

Hon. Sec.: Mr. F. Bell, 118, Colin Crescent, Hendon, London, N.W.9.

Meetings are in future being held at the home

of G3HT, Gainsborough Gardens, Edgware, on Wednesdays. Morse classes are held at the Secretary's house at 11 a.m. on Sundays.

South Hants Radio Transmitting Society

Headquarters: Senior Boys' School, Fareham, Hants.

Hon. Sec.: Mr. J. S. K. Stephens, 65, Ebery Grove, Copnor, Portsmouth, Hants.

In spite of the ban on transmitting it has been decided to carry on with meetings, which will be held on Sunday afternoons at members' addresses. Full particulars can be obtained from the Hon. Sec.

Slough and District Short-wave Club

Headquarters: Toc. H. Headquarters, William Street, Slough, Bucks.

Meetings: Alternate Thursdays, at 7.30 p.m.

Hon. Sec.: Mr. K. A. Sly, 16, Buckland Avenue, Slough, Bucks.

It has been decided to carry on as usual throughout the war. For the time the present headquarters will be retained. Morse practice is to be continued. The agenda for future meetings of the club includes further talks in the series entitled "Measuring Equipment," and a talk entitled "Receiver Construction." Junk sales will be held periodically. The subscription is to remain at 2s. 6d. per annum, plus a further 3d. payable at each meeting.

Eastbourne and District Radio Society

Headquarters: The Science Room, Cavendish Senior School, Eastbourne, Sussex.

Hon. Sec.: Mr. T. G. R. Dowsett, 48, Grove Road, Eastbourne, Sussex.

At the last pre-war meeting of the society, a cinema film entitled "Milestones of Radio" was shown to an unusually large audience. This film told the story of radio development from the time of Marconi's early experiments. This film was followed by two other films entitled "City of Sound" and "Mazda in the Making," both illustrating commercial activities. At the September 23th meeting, Mr. R. Bridgeland gave a demonstration of some of his apparatus.

Recognising German Aircraft

AN interesting chart has been published by *Flight*, the well-known aeronautical weekly, giving recognition drawings of all the principal German military aircraft. Brief descriptions of each machine are also given. The chart, which is mounted on stiff cardboard, and is suitable for hanging up, is obtainable at a cost of eightpence post free from the offices of *Flight*, at Dorset House, Stamford Street, London, S.E.1.



WIRELESS - CONTROLLED MODEL AIRCRAFT. These photographs from America show a petrol-driven model of 10 ft. wing span of which all the controls are actuated through a 5-metre transmitter on the ground. Above is a close-up view of the receiver, which includes 4 valves and weighs only 15 ozs. The selector unit, for translating electrical impulses into mechanical action, is also seen.

VORTEXION

15w. AC & 12-VOLT DC AMPLIFIER



Type CP20

This small Portable Amplifier, operating either from AC mains or 12-volt battery, was tested by **THE WIRELESS WORLD**, October 1st, 1937, and has proved so popular that at Customers' demand it remains unaltered except that the output has been increased to 17.2 watts and the battery consumption lowered to 6 amperes. Read what "The Wireless World" said:—

"During tests an output of 14.7 watts was obtained without any trace of distortion so that the rating of 15 watts is quite justified. The measured response shows an upper limit of 18,000 c/s and a lower of 30 c/s. Its performance is exceptionally good. Another outstanding feature is its exceptionally low hum level when AO operated even without an earth connection. In order to obtain the maximum undistorted output, an input to the microphone jack of 0.037 volt was required. The two independent volume controls enable one to adjust the gain of the amplifier for the same power output from both sources, as well as superimpose one on the other, or fade out one and bring the other up to full volume. The secondary of the output transformer is tapped for loudspeakers or line impedances of 4, 7.5 and 15 ohms."

AC and 12-volt CHASSIS with valves, etc. **£12 12 0**
Or in Rexine Case with Collaro Motor, Piezo P.U. and Mike Transformer **£17 17 0**

AC only CHASSIS with valves, etc. **£8 18 6**
Or in Rexine Case with Collaro Motor, Piezo P.U. and Mike Transformer **£14 0 0**

Gauze Case for either chassis 12/6 extra.

Many hundreds already in use for
A.R.P. & GOVERNMENT purposes

50W AMPLIFIER CHASSIS

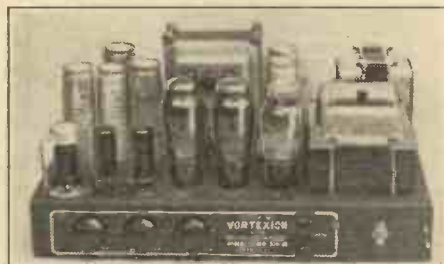

A pair of matched 6L6's with 10 per cent. negative feed-back is fitted in the output stage, and the separate HT supplies to the anode and screen have better than 4 per cent. regulation, while a separate rectifier provides bias.

The 6L6's are driven by a 6F6 triode connected through a driver transformer incorporating feedback. This is preceded by a 6N7 electronic mixing for pick-up and microphone. The additional 6F5 operating as first stage on microphone only is suitable for any microphone. A tone control is fitted, and the large eight-section output transformer is available in three types:—2-8-15-30 ohms; 4-15-30-60 ohms or 15-60-120-250 ohms. These output lines can be matched using all sections of windings and will deliver the full response (40-18,000 c/s) to the loudspeakers with extremely low overall harmonic distortion.

CHASSIS with valves and plugs **£17 10 0**
Or complete in black leatherette cabinet with Collaro turntable, Piezo P.U. and shielded Mike Transformer **£22 10 0**

Goodmans P.A. Speakers in stock.

Reslo Horns **£11 11 0**

Reslo M.C. Microphones **£3 15 0**

Amperite Ribbon Microphones from **£5 5 0**

AB P.A. and A.R.P. Warning Gear in stock.

Write for Illustrated Catalogue.

Vortexion Ltd., 182, The Broadway, Wimbledon, S.W.19. 'Phone: LIBerty 2814.

Short-wave Stations of the World

Arranged in Order of Frequency and Wavelength

Station	Call Sign	Mc/s.	Metres	kW	Station	Call Sign	Mc/s.	Metres	kW
Moscow (U.S.S.R.)	RIA	5.85	51.24	15	Winnipeg (Canada)	CJRX	11.72	25.60	2
Moscow (U.S.S.R.)	RNE	6.00	50.00	20	Huizen (Holland)	PHI	11.73	25.58	20
Zeesen (Germany)	DJC	6.02	49.83	5-40	Oslo (Norway)	LKQ	11.73	25.56	5
Moscow (U.S.S.R.)	RW96	6.03	49.75	100	Boston (U.S.A.)	WRUL	11.73	25.56	20
Vatican City	HVJ	6.03	49.75	25	Vatican City	HVJ	11.74	25.55	25
Boston (U.S.A.)	WRUL	6.04	49.67	20	Warsaw (Poland)	SP25	11.74	25.55	5
British Oversea Service	GSA	6.05	49.59	10-50	British Oversea Service	GSD	11.75	25.53	10-50
Philadelphia (U.S.A.)	WCAB	6.06	49.50	10	Rome (Italy)	I2RO15	11.76	25.51	—
Motala (Sweden)	SPO	6.06	49.46	12	Zeesen (Germany)	DJD	11.77	25.49	5-40
Zeesen (Germany)	DJN	6.08	49.35	5-40	Boston (U.S.A.)	WRUL	11.79	25.45	20
Bound Brook (U.S.A.)	WNBI	6.10	49.18	25	Zeesen (Germany)	DJO	11.80	25.42	5-40
Belgrade (Yugoslavia)	YUA	6.10	49.18	1	Tokio (Japan)	JZJ	11.80	25.42	50
British Oversea Service	GSL	6.11	49.10	10-50	Rome (Italy)	I2RO4	11.81	25.40	100
Wayne (U.S.A.)	WCBX	6.12	49.02	10	British Oversea Service	GSN	11.82	25.38	10-50
Sinkiang (Manchukuo)	MYCY	6.12	49.02	—	Wayne (U.S.A.)	WCBX	11.83	25.36	10
Warsaw (Poland)	SP48	6.14	48.86	5	Lisbon (Portugal)	CSW5	11.84	25.34	10
Pittsburgh (U.S.A.)	WPIT	6.14	48.86	28	Zeesen (Germany)	DJP	11.85	25.31	5-40
Winnipeg (Canada)	CJRO	6.15	48.78	2	Budapest (Hungary)	HAD	11.85	25.31	—
Wayne (U.S.A.)	WCBX	6.17	48.62	10	British Oversea Service	GSE	11.86	25.29	10-50
Vatican City	HVJ	6.19	48.47	25	Madras (India)	VUM2	11.87	25.28	10
Rome (Italy)	IAC	6.35	47.21	50	Pittsburgh (U.S.A.)	WPIT	11.87	25.26	24
Radio-Nations (Switzerland)	HBQ	6.67	44.94	20	Melbourne (Australia)	VLR3	11.88	25.25	2
Barcelona (Spain)	EAQ1	7.03	42.7	—	Radio-Mondial (France)	TPA11/12	11.88	25.24	12
Valladolid (Spain)	FET1	7.07	42.43	0.25	Moscow (U.S.S.R.)	RNE	12.00	25.00	20
Burgos (Spain)	EA1BO	7.07	42.43	—	Reykjavik (Iceland)	TFJ	12.23	24.52	7.5
Lisbon (Portugal)	CSW8	7.26	41.32	10	Warsaw (Poland)	SPW	13.63	22.00	10
Radio-Mondial (France)	TPB7/11	7.28	41.21	25	Radio-Nations (Switzerland)	HPJ	14.54	20.64	20
Moscow (U.S.S.R.)	RWG	7.36	40.76	15	Rome (Italy)	IQA	14.79	20.28	—
Moscow (U.S.S.R.)	RKI	7.51	39.89	25	Moscow (U.S.S.R.)	RKI	15.04	19.95	25
Budapest (Hungary)	HAT4	9.12	32.88	5	Rome (Italy)	I2RO12	15.10	19.87	—
Radio-Nations (Switzerland)	HBL	9.34	32.1	20	Zeesen (Germany)	DJL	15.11	19.85	5-40
Ankara (Turkey)	TAP	9.46	31.70	20	Vatican City	HVJ	15.12	19.84	25
Lahti (Finland)	OED	9.50	31.58	1	Warsaw (Poland)	SP19	15.12	19.84	5
Chungking (China)	XGOY	9.50	31.58	35	Radio-Mondial (France)	TPB6	15.13	19.83	25
Melbourne (Australia)	VK3ME	9.51	31.55	5	British Oversea Service	GSF	15.14	19.82	10-50
British Oversea Service	GSB	9.51	31.55	10-50	Motala (Sweden)	SPT	15.15	19.80	12
Moscow (U.S.S.R.)	RW96	9.52	31.51	100	Tokio (Japan)	JZK	15.16	19.79	50
Warsaw (Poland)	SP31	9.52	31.49	5	Oslo (Norway)	LKV	15.17	19.78	5
Schenectady (U.S.A.)	WGEO	9.53	31.48	100	Moscow (U.S.S.R.)	RW96	15.18	19.76	100
Calcutta (India)	VUC2	9.53	31.48	10	British Oversea Service	GSO	15.18	19.76	10-50
Motala (Sweden)	SBU	9.53	31.46	12	Zeesen (Germany)	DJB	15.20	19.74	5-40
Vatican City	HVJ	9.55	31.41	25	Ankara (Turkey)	TAQ	15.20	19.74	20
Schenectady (U.S.A.)	WGEA	9.55	31.41	20-25	Pittsburgh (U.S.A.)	WPIT	15.21	19.72	18
Bombay (India)	DUB2	9.55	31.40	10	Lisbon (Portugal)	CSW4	15.21	19.72	10
Zeesen (Germany)	DJA	9.56	31.38	5-40	Huizen (Holland)	PCJ2	15.22	19.71	60
Millis (U.S.A.)	WBOS	9.57	31.35	10	Podebrady (Bohemia)	OLR5A	15.23	19.70	15-30
British Oversea Service	GSC	9.58	31.32	10-50	Rome (Italy)	I2RO14	15.23	19.70	—
Melbourne (Australia)	VLR	9.58	31.32	2	Radio-Mondial (France)	TPA2	15.24	19.68	12
Sydney (Australia)	VK2ME	9.59	31.28	20	British Oversea Service	GS1	15.26	19.66	10-50
Huizen (Holland)	PCJ	9.59	31.28	60	Philadelphia (U.S.A.)	WCAB	15.27	19.65	10
Philadelphia (U.S.A.)	WCAB	9.59	31.28	10	Schenectady (U.S.A.)	WGEA	15.27	19.65	20-25
Delhi (India)	VUD2	9.59	31.28	10	Zeesen (Germany)	DJQ	15.28	19.63	5-40
Athlone (Ireland)	—	9.59	31.27	—	Delhi (India)	VUD4	15.29	19.62	10
British Oversea Service	GRY	9.60	31.25	10-50	Rome (Italy)	I2RO6	15.30	19.61	50
Moscow (U.S.S.R.)	RAL	9.60	31.25	20	British Oversea Service	GSP	15.31	19.60	10-50
Cape Town (S. Africa)	ZRL	9.61	31.23	5	Schenectady (U.S.A.)	WGEA	15.33	19.57	20-25
Oslo (Norway)	LLG	9.61	31.22	5	Zeesen (Germany)	DJR	15.34	19.56	5-40
Budapest (Hungary)	HAD	9.62	31.17	—	Budapest (Hungary)	HAS3	15.37	19.52	5
Rome (Italy)	I2RO3	9.63	31.15	25-100	Moscow (U.S.S.R.)	RAL	15.15	19.35	15
Wayne (U.S.A.)	WCBX	9.65	31.09	10	Oslo (Norway)	LKW	17.75	16.90	5
Lisbon (Portugal)	CS2WA	9.65	31.09	2	Zeesen (Germany)	DJE	17.76	16.89	5-40
Vatican City	HVJ	9.66	31.06	25	Huizen (Holland)	PHI	17.77	16.88	20
Buenos Aires (Argentina)	LRX	9.66	31.06	7.5	Bound Brook (U.S.A.)	WNBI	17.78	16.87	35
Rome (Italy)	I2RO9	9.67	31.02	25	Tokio (Japan)	JZL	17.78	16.87	50
Zeesen (Germany)	DJX	9.67	31.02	5-40	British Oversea Service	GSG	17.79	16.86	10-50
Bound Brook (U.S.A.)	WRCA	9.67	31.02	35	British Oversea Service	GSV	17.81	16.84	10-50
British Oversea Service	GRX	9.69	30.96	10-50	Rome (Italy)	I2RO8	17.82	16.84	50
Buenos Aires (Argentina)	LRA1	9.69	30.96	10	Wayne (U.S.A.)	WCBX	17.83	16.83	10
Lisbon (Portugal)	CSW7	9.74	30.80	10	Athlone (Ireland)	—	17.84	16.82	—
Rome (Italy)	IRF	9.83	30.52	30	Radio-Mondial (France)	TPB3	17.85	16.81	25
Madrid (Spain)	EAQ	9.86	30.43	10	Radio-Nations (Switzerland)	HBH	18.48	16.23	20
Buenos Aires (Argentina)	LSX	10.35	28.99	12	Zeesen (Germany)	DJS	21.45	13.99	5-40
Lisbon (Portugal)	CSW6	11.04	27.17	10	British Oversea Service	GSH	21.47	13.97	10-50
Radio-Nations (Switzerland)	HBO	11.40	26.31	20	Schenectady (U.S.A.)	WGEA	20.50	13.95	20-25
Warsaw (Poland)	SPD	11.53	26.01	2	Rome (Italy)	I2RO16	21.52	13.94	—
Rome (Italy)	IQY	11.67	25.70	—	Philadelphia (U.S.A.)	WCAB	21.52	13.94	10
Motala (Sweden)	SBP	11.70	25.63	12	British Oversea Service	GSJ	21.53	13.93	1050
Moscow (U.S.S.R.)	IRA	11.71	25.62	15	Pittsburgh (U.S.A.)	WPIT	21.53	13.93	6-
Radio-Mondial (France)	TPA4	11.72	25.60	12	British Oversea Service	GST	21.55	13.92	10-50

Recent Inventions

Brief descriptions of the more interesting radio devices and developments disclosed in Patent Specifications will be included in these columns.

RECEIVING CIRCUITS

THE Figure shows a circuit which is designed to allow the apparent modulation of an incoming signal to be increased at the receiving end. For instance, in a superheterodyne receiving weakly modulated signals, the carrier-wave can be reduced, relatively to the sidebands, so as to prevent any risk of overloading the subsequent RF valves.

The modulated carrier (or the modulated intermediate frequency) is applied to the control grid of a SG valve V from input terminals A, B which are shunted by a circuit L tuned to the

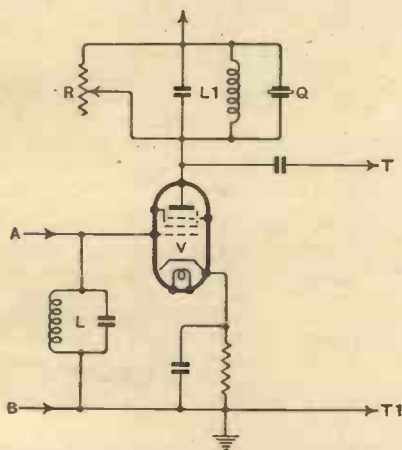

Circuit for varying signal modulation.

carrier-wave. The anode of the valve includes a similar circuit L1 also tuned to the carrier. This, in turn, is shunted by a piezo-electric crystal Q sharply resonant to the carrier, and by an adjustable resistance R. The attenuation of the carrier, relatively to the side-band frequencies, is then controlled by varying the value of the resistance R. The output, with its relatively increased signal content, is taken off from the terminals T, T1.

Marconi's Wireless Telegraph Co., Ltd., and O. E. Keall. Application date December 10th, 1937. No. 507220.

CATHODE-RAY TUBES

VARIOUS kinds of sensitised screens are used inside a cathode-ray tube, such as fluorescent screens for reception, photo-electric screens for transmission, and screens coated with substances having a high coefficient of secondary emission for intensifying the strength of the electron stream. In each case the effective life of the tube is determined by that of the screen.

According to the invention such screens are made of larger area than usual, and are arranged to be rotated slowly but

continuously, so that the electron stream impacts upon a different part of the screen from time to time, instead of upon the same area, thus reducing the wear and tear on the screen as a whole and prolonging the life of the tube. The arrangement is particularly suitable for the so-called projection type of tube in which a beam of very high intensity scans a comparatively small area.

The periphery of the screen may be formed with wings or ridges, similar to those used on the rotor of a turbine. The stream is then periodically deflected, say by the synchronising impulses, on to these marginal parts, and so automatically rotates the screen in the manner described.

Scophony, Ltd., and A. H. Rosenthal. Application date January 18th, 1938. No. 508712.

SCANNING SYSTEMS

IT is possible to minimise "keystone" distortion, in a mechanical scanning system, by projecting the light at an angle to the plane of the rotating disc. This, however, reduces the effective area of the spot of light that passes through the scanning holes by a factor proportional to the size of the angle; also more of the light is "scattered" when passing through the aperture at an inclination.

Both drawbacks are avoided by punching larger apertures in the scanning disc and then covering them by a backing plate of thin copper in which holes of the desired size have been made. The edges of the latter are bevelled so that they lie parallel to the passing beam of light.

Radio Aktiengesellschaft D. S. Loewe. Convention date (Germany) March 8th, 1937. No. 506691.

CATHODE-RAY INDICATORS FOR DF

IN a direction-finding system using two crossed frame-aerials A, B, the pick-up voltage from each frame is fed in rapid alternation through a reversing switch K to two separate amplifiers V, V1, and then through a second reversing switch K1, operated in synchrony with the first, to the deflecting-plates of a cathode-ray tube T.

The purpose of the reversing switches is to compensate for any lack of balance in the operating characteristics of the two amplifiers V, V1. For instance, if there were no reversal of the signal pick-up, then the direction of the incoming

signal would be shown on the fluorescent screen by a single narrow ellipse. The effect of reversing the amplifiers, should any difference exist in their working characteristics, is to produce two narrow ellipses such as 1, 2. The true bearing is then taken as the line bisecting the angle between the two ellipses.

Telefunken Gesellschaft für drahtlose Telegraphie m.b.H. Convention date (Germany) December 11th, 1937. No. 506630.

AERIAL COUPLINGS

THE coaxial feed line from the output stage of a short-wave transmitter is coupled to the aerial through an auto-transformer wound on a powdered-iron core. The transformer is so dimensioned that, at resonance, the stray field is so small that the load is virtually a purely ohmic one. This simplifies impedance matching, and allows the same aerial to be used for a number of different wavelengths.

C. Lorenz Aktiengesellschaft. Convention date (Germany), August 10th, 1937. No. 506977.

ELIMINATING INTERFERENCE

A METHOD of increasing the signal-to-noise ratio of a wireless receiver is based upon the fact that the signal energy drawn from the incoming carrier wave varies with time, rising and falling with the carrier-wave amplitude. This is true, of course, in the case of "interference" energy, but the latter usually varies in an irregular or "peaked" sequence, whilst the carrier wave is of regular or sinusoidal form.

The receiving circuits are accordingly opened and shut at a regular frequency, which is a sub-multiple of the carrier frequency, the timing of the control being such that the circuits are always "open" when the carrier amplitude is at maximum. In these circumstances it seldom happens that the "open" periods will

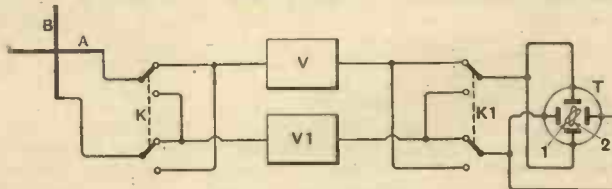

Visual DF indicator.

coincide with the moment when the irregular interfering signal is also at a maximum. In other words, by arranging the receiving circuits to be always "open" when the incoming signals are at maximum strength, and to be usually "blocked" when the "noise" is at maximum strength, the average effect of

Recent Inventions—

any interference that may be present is considerably reduced.

The General Electric Co., Ltd.; N. R. Bligh, and A. Block. Application date October 21st, 1937. No. 507839.

DIRECTION FINDERS

IN a known form of automatic or direct-reading instrument, the bearing line of a distant transmitter is shown either on the fluorescent screen of a cathode-ray tube, or on some equivalent form of visual indicator, as a "double-leaved" trace such as that shown at A or B in the Figure, the critical direction being along the major axis AA or BB of the double "leaf."

In practice, various causes, such as the "vertical" effect of the frame aerial, or the presence of a "static,"

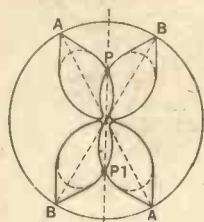

Increasing accuracy of visual DF.

tend to round-off the ends of the leaf in the manner shown in dotted lines, thus making it difficult to determine the true direction of the major axis.

According to the invention the indicator is arranged so that it produces two leaf-shaped traces, such as A, B set at an angle to each other. The true bearing-line is then indicated by the direction of the two points P, P₁ of overlap, and since these occur along the flanks of the leaf they are not affected by the circumstances which tend to blur the sharpness of the pointed ends of the usual form of trace.

Telefunken Gesellschaft für drahtlose Telegraphie m.b.h. Convention date (Germany) June 26th, 1937. No. 508139.

ELECTRON MULTIPLIERS

THE object of the invention is to arrange the "target" electrodes of an electron-multiplier so that the stream of secondary electrons, produced after impact, continues through the multiplier tube in the same direction as the primary electrons, and so that all the electrons in the secondary stream travel at substantially the same speed.

This result is secured, according to the invention, by making each target electrode in the form of a series of inclined strips which overlap like the slats of a louver blind so as to prevent the free passage of any of the primary electron stream. The "forward" face of each slat is coated with emissive material, whilst the rear face consists either of material of high work-function or of high insulation. The liberation of secondary electrons then causes the rear face to become charged to a sufficiently high positive potential to prevent any of the secondary stream from being trapped. Instead they take a curved path to pass

through the "openings" in the louvered electrode, and then pass straight on towards the highly positive anode.

H. G. Lubszynski and J. D. McGee. Application dates November 24th, 1937, and June 3rd, 1938. No. 508106.

"WATCH-DOG" CIRCUITS

A VALVE, set more or less on the threshold of oscillation, can be used to give warning, say, of the approach of an unauthorised person to a locality or object, or as a burglar or other "watch-dog" alarm, by causing the capacity changes due to the approach of the person to throw the valve into self-oscillation and so operate an alarm.

According to the invention, a triode hexode valve is used for this purpose, the "aerial" or feeler (which responds to the capacity effect of the intruding person) being coupled to the grid of the triode portion of the valve, whilst the hexode portion is tuned to resonance and electronically coupled to the triode. The arrangement is flexible as regards operating frequency, and stable in operation.

J. Cochrane. Application date October 21st, 1937. No. 509922.

VARIABLE SELECTIVITY

IN a wireless set where the degree of selectivity is primarily controlled by the tightness of the coupling between two tuned circuits, the range of wavelengths over which the control is effective, and also the width and form of the band-pass input, are further regulated by arranging that, as the direct coupling is tightened, the feedback coupling through the amplifier valve is decreased, and vice versa.

For instance, the two coils L₁, L₂ are fixed on the same former, whilst two other coils L₃, L₄ are fixed on a second former, which is mounted to slide over the first. As the coil L₃ is moved closer to the coil L₁, so as to tighten the direct coupling between the circuit A and the circuit B (containing the coils L₂, L₃ in series), the coil L₄ is simultaneously moved away from the coil L₂, so as to reduce the back coupling between the plate and grid circuits of the amplifier.

Telefunken Gesellschaft für drahtlose Telegraphie m.b.h. Convention date (Germany) December 24th, 1936. No. 508042.

CAR AERIALS

FOR automobile work it is generally necessary to use a low capacity, high impedance aerial in order to pick up satisfactory signal strength. A typical example is a rod extending vertically from some part of the car. As this cannot be closely "matched" to the

The British abstracts published here are prepared with the permission of the Controller of H.M. Stationery Office, from specifications obtainable at the Patent Office, 25, Southampton Buildings, London, W.C.2, price 1/- each.

impedance of the input circuit of the receiver, a substantial loss of signal energy is involved.

According to the invention, the low capacity aerial is connected, in series with a choke coil, to a lead-in wire covered by a screen which has a comparatively large capacity to earth. The choke is preferably made of two sections of Litz wire and has an inductance of 400 microhenrys. The capacity of the aerial to earth is of the order of 17 m-mfds., whilst that of the screen is 100 m-mfds. The arrangement also serves to reduce the transfer of inductive "noise."

G. W. Johnson (communicated by Philco Radio and Television Corporation). Application date November 1st, 1937. No. 508579.

LARGE-SCREEN TELEVISION

THE use of ordinary lenses for projecting the picture from the fluorescent screen of a cathode-ray tube on to an external viewing screen gives rise to a considerable loss of the available light. Even with a wide-aperture lens, a large percentage of the light is lost, particularly when the radiating surface of the fluorescent screen faces away from the external screen.

According to the invention, the difficulty is overcome by fitting the back of the fluorescent screen with a mosaic of small optical lenses. For example, a large number of small hemispherical pieces of glass are mounted on the back

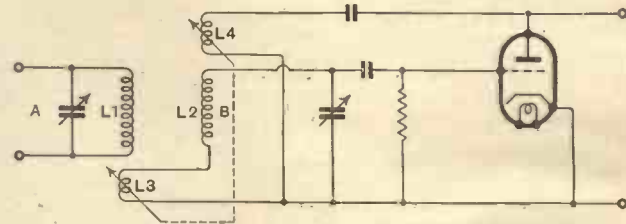

Circuit for differential circuit coupling.

of the screen carrier by an adhesive material of low refractive index. Each lens should be of approximately the same size as the scanning spot. The mosaic catches the light from each picture point and converts it into parallel rays, which can then be projected, without appreciable loss, on to the viewing screen, resulting in a picture of considerably enhanced brilliancy.

Fernseh Aktiengesellschaft. Convention date (Germany) November 17th, 1936. No. 505850.

You can't SEE the Difference, BUT ..

To the eye, there is little difference between one year's speaker and another. But we are particularly proud of the performance of our latest models. We do not claim to have reached ultimate perfection; but we do know that as a result of thirteen years' specialised research we have come nearer to it than has previously been achieved. Every operation from raw material to finished Speaker is carried out in our own Factories and under W.B. control, thus bringing exceptional advantages in reliability and economy of price. In all confidence we ask you to hear a W.B. Speaker. Your local dealer stocks them and will be glad to demonstrate. Please ask him.

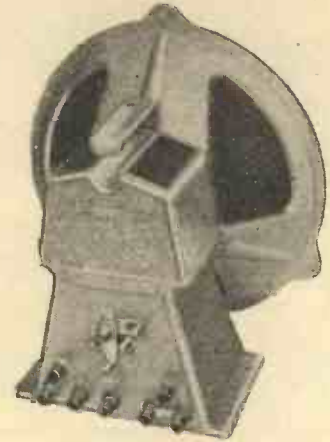

Stentorian

UNIVERSAL PRINCIPAL & EXTENSION SPEAKERS

WHITELEY ELECTRICAL RADIO CO. LTD., MANSFIELD, NOTTS.

CHASSIS MODELS:

Senior	£2 . 6 . 3
Junior	£1 . 12 . 9
Baby	£1 . 6 . 0
Midget	19 . 3
Cabinet Models from 21/6.	

Fourth Edition of

—Revised and enlarged with 50 additional pages

WIRELESS SERVICING MANUAL

By W. T. COCKING (of "The Wireless World")

Cloth Boards
Size 7½ ins. x 5 ins.
288 Pages.

5/- net
By Post 5/5.

The most complete book of reference of its kind. A reliable practical guide for amateur and professional.

The "Wireless Servicing Manual" deals fully with Testing Apparatus, and explains the methods of locating and curing faults in receiving equipment, and includes an additional chapter on television receivers.

Ganging, Automatic Volume Control, Instability, Distortion, Mains Hum, Whistles and Local Interference are all separately treated. There is also a special chapter on the Aerial-Earth System.

Information on short-wave receivers, and on methods of operating extension loud speakers, is also given.

Issued in conjunction with "THE WIRELESS WORLD" and Published by the Proprietors:—

ILIFFE & SONS LTD., DORSET HOUSE, STAMFORD STREET, LONDON, S.E.1

W.W.20

INDEX TO ADVERTISEMENTS

	PAGE		PAGE		PAGE
All-Power Transformers	8	Garrard Eng. Co., Ltd.	6	Postlethwaite	8
Ambassador Radio Works	6	General Electric Co., Ltd.	Inside Front Cover	Premier Radio	9
Armstrong Manufacturing Co.	14	Henley, W. T., Telegraph Works Co., Ltd. ..	8	Savage, W. Bryan, Ltd.	8
Automatic Coil Winder Co., Ltd.	1	H.M.V.	Back Cover	Simmonds Aeroccessories, Ltd.	3
Birmingham Radiomart G5N1	4	Institute of Wireless Technology	18	Sound Sales, Ltd.	4
British Institute of Engineering Technology ..	18	London Radio Supply Co.	15	Standard Telephones & Cables, Ltd.	5
British Insulated Cables, Ltd. Inside Back Cover		Masters, C. E.	8	Stratton & Co., Ltd.	15
British Mechanical Productions, Ltd.	17	McClure, Ltd.	2	Summers, John, & Sons, Ltd. ...	Inside Back Cover
British Thomson-Houston Co., Ltd., The ..	2	M.R. Supplies	6	Vidor	10
Bulgin, A. F., & Co., Ltd.	Edit. p. 33	Murphy Radio, Ltd.	12	Voigt Patents, Ltd.	15
Dubilier Condenser Co. (1925), Ltd.	7	Partridge, N.	18	Vortaxion, Ltd.	Edit. p. 35
Electradix Radios	16	Peto-Scott Co., Ltd.	11, 17	Ward, C. F.	8
Fluxite, Ltd.	Edit. p. 29	Pifco, Ltd.	Inside Back Cover	Webbs Radio	8
Galpin's Electrical Stores	8	Player's Cigarettes	Inside Back Cover	Westinghouse Brake & Signal Co., Ltd.	4
				Whiteley Electrical Radio	13

Mention of "The Wireless World," when writing to advertisers, will ensure prompt attention.

The Wireless World

CLASSIFIED ADVERTISEMENTS

THE CHARGE for advertisements in these columns is 12 words or less 3/-, 3d. for every additional word. Each paragraph is charged separately.

ADVERTISEMENTS, with remittance, should reach Dorset House, Stamford Street, S.E.1, not later than first post Tuesday, November 14th, for the December issue, or one day earlier at the Branch Offices, 8-10, Corporation Street, Coventry; Guildhall Buildings, Navigation Street, Birmingham, 2; 260, Deansgate, Manchester, 3; 26a, Renfield Street, Glasgow, C.2.

SERIES DISCOUNTS are allowed to trade advertisers on orders for consecutive insertions provided a contract is placed in advance, and in the absence of fresh instructions the entire copy is repeated from the previous issue. 3 insertions, 5 per cent.; 6 ins., 10 per cent.; 12 ins., 15 per cent.

Advertisements received too late for one issue, or crowded out, are published in the first following in which there is space. The Proprietors retain the right to refuse or withdraw advertisements at their discretion.

The Proprietors are not responsible for clerical or printer's errors, although every care is taken to avoid mistakes.

BOX NO. ADVERTISERS should include the words "Box 000 c/o 'The Wireless World'" which must be paid for. An additional 6d. is charged for registration and cost of forwarding replies.

ARMSTRONG

ANNOUNCE

that in accordance with their well-known Fair Trading Policy, there will be

NO INCREASE IN PRICES

whilst present stocks of chassis last. As it becomes necessary for us to purchase new material, we shall raise the prices only by the actual amount of our increased costs.

We can give immediate delivery of all Models described in our 1940 Catalogue except No. SS2B.

Send for our illustrated Art Catalogue which fully describes our full range, including the following:

MODEL SS10 — 10-V SUPERHET-STRAIGHT ALL-WAVE HIGH-FIDELITY R-G CHASSIS

Incorporating Two Independent Circuits, Superheterodyne and Straight, having R.F. Pre-amplifier and R.C. Coupled Push-Pull Triode Output capable of handling 8 watts.

Letters addressed to Box Nos. are simply forwarded to the advertiser. No responsibility is accepted in connection with these advertisements.

DEPOSIT SYSTEM. Readers may deal with advertisers in safety through our Deposit System. Purchase money payable to Liffe & Sons Ltd. should be deposited with "The Wireless World," when both parties are advised of its receipt.

The time allowed for decision is three days, counting from receipt of goods, after which period, if buyer decides not to retain goods, they must be returned to sender. If a sale is effected, buyer instructs us to remit amount to seller, but if not, seller instructs us to return amount to depositor. Carriage is paid by the buyer, but in the event of no sale, and subject to there being no different arrangement between buyer and seller, each pays carriage one way. The seller takes the risk of loss or damage in transit, for which we take no responsibility. For transactions up to £10 a deposit fee of 1/- is charged; over £10 and under £50, 2/6; over £50 and under £75, 5/-; over £75 and under £100, 7/6; over £100 one-half per cent. All correspondence must be sent to Dorset House, Stamford Street, London, S.E.1.

Cheques sent in payment for deposits or advertisements should be made payable to Liffe & Sons Ltd. and crossed. Notes which are untraceable if lost in transit should not be forwarded except in registered envelopes.

NEW RECEIVERS AND AMPLIFIERS

A.
A.

"CHALLENGER RADIO CORPORATION," the best firm for reliable, fully guaranteed ultra short-wave radio, have on view in London without exception the finest receivers ever made; for instance, a T.R.F. Midget (2 bands) at £3/16, a mains/battery transportable (operating without alteration to A.C., D.C. or batteries), at £7/17/6; a 13-valve receiver, 5 bands, 5-2,100 metres, is only £16/2; any American valve for receivers 1925-40 for 5/6 each, only firsts such as Rathon Ken-rad, etc., supplied; they have a range like this right up to an 18-valve Challenger Twin-Chassis De Luxe, valves and 12in. public address speaker (weight 23lb.), at 30 gns.; why not call and handle these receivers at your leisure? No obligation to purchase; or handsome, profusely illustrated catalogues forwarded on receipt of 2d. stamp; sale list of 1939 receivers also available.

CHALLENGER RADIO CORPORATION, 31, Craven Terrace, London, W.2. Paddington 6492. Nearest post Marble Arch, down Bayswater Rd., turn 5th right. [8731]

BAKERS' 9-valve Quality Receiver and Amplifier, with 7-watt push outfit, brand new; £10/10; usual price £21; complete in polished walnut cabinet; ideal for use with Baker and other quality speakers.—Bakers Selhurst Radio, 75, Sussex Rd., South Croydon. [8723]

USED SETS FOR SALE

MARCONI

MARCONI 222 Allwave Battery Set, good condition; £3/5; owner changed A.C.—Chattel, High St. North, Dunstable. 'Phone: 340. [8727]

PHILIPS

PHILIPS Special Shortwave Receiver 362A, range 5-550 metres, 230 volts A.C., as new, in maker's packing, very fine station getter; £15.—Lavin, Old House, Sonning, Reading. [8714]

PUBLIC ADDRESS

PARTRIDGE P.A. Manual, standard handbook on electro-acoustics, amplifiers, and audio circuits; price 2/6 (free to trade).

PARTRIDGE Amplifier Circuits, describes many modern constructional amplifiers, 2w. to 45w. output, battery, A.C.D.C., etc.; price 2/- (no free copies).

PARTRIDGE, N., B.Sc. A.M.I.E.E., King's Buildings, Dean Stanley St., London, S.W.1. [0630]

PUBLIC Address Contractors Can Hire P.A. Vans, loud speakers, microphones and equipments of all types from Hire Dept., Gramplan Reproducers, Ltd., Kew Gardens, Surrey. Tel.: Richmond 1175-6-7. [0618]

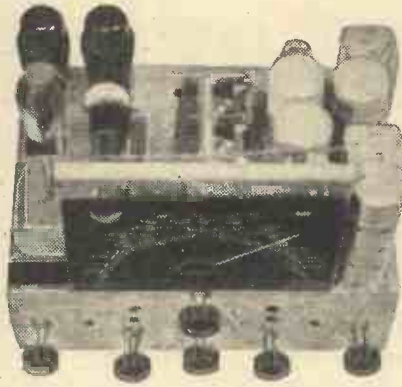

The circuit of the SS10 is unique. When used as a STRAIGHT receiver two HF stages are in operation with A.V.C. Diode Detector is used for distortionless detection together with Triode Push-Pull output. A turn of only one knob is necessary to switch from "Superhet" to "Straight." The Gramophone Amplifier has been specially studied and records can be reproduced with excellent quality..... 12 gns.

MODEL AW38—8-V ALL-WAVE SUPERHET

This radiogram chassis has R.C. Coupled Push-Pull Output capable of handling 6 watts.

This being our Quality Year we have carefully studied the design of our more economically priced models and it's now possible for those requiring 8 gns. quality with economy to satisfy their desire. 8 gns.

MODEL AW93PP—9-V ALL-WAVE SUPERHET

A radiogram chassis with 3 wavebands R.F. Pre-Amplifier, 3 stages of A.V.C. and 8 watts R.C. Coupled Triode P.P. output..... 10 gns.

MODEL AW125PP—12-V 5-BAND ALL-WAVE R-G CHASSIS (12-550 continuous, 1000-2000 m)

with R.F. Pre-Amplifier, 2 I.F. stages with Variable Selectivity. Manual R.F. gain control and 10 watts R.C. Coupled Triode-P.P. Output.

Readers need no introduction to this most popular model, so favourably reviewed by The Wireless World on Jan. 5th last. 17 gns.

7 DAYS' APPROVAL—12 MONTHS' GUARANTEE ARMSTRONG MANUFACTURING CO.

WALTERS ROAD, HOLLOWAY, LONDON, N.7 (Adjoining Holloway Arcade). 'Phone: NORTH 3213.

PUBLIC ADDRESS

V

VORTEXION P.A. Equipment.

IMITATED, but unequalled.

WE Invite You to a Demonstration.

A.C.D.C. Dance Band Amplifier, 10 watts output, complete in case, with moving coil, microphone, speaker and cables, weight 22lb.; 12 gns.

A.C.-20 15-20-watt Amplifier, 38-18,000 cycles, independent mike and gram, inputs and controls, 0.037 volts required to full load, output for 4, 7.5, and 15 ohms speakers, or to specification, inaudible hum level, ready for use; 8½ gns. complete.

C.P. 20 12-volt Battery and A.C. Mains Model, as used by R.A.F., output as above; 12 gns.

A.C.-20, in portable case, with Collard motor, Piezo pick-up, etc., £14; C.P.20 ditto, £17/17.

50-WATT Output 6L6s, under 60-watt conditions, with negative feed back, separate rectifiers for anode screen and bias, with better than 4% regulation level response, 20-25,000 cycles, excellent driver, driver transformer, and output transformer matching 2-30 ohms impedance electronic mixing for mike and pick-up, with tone control, complete with valve and plugs; £17/10.

COMPLETE in Case, with turntable, B.T.H. Piezo pick-up and shielded microphone transformer; £22/10.

80-WATT Model, with negative feed back; £25, complete.

120-WATT Model, with negative feed back; £40, complete.

250-VOLT 250 m.a. Full Wave Speaker field supply unit; 25/-, with valve.

ALL P.A. Accessories in Stock; trade supplied.

VORTEXION, Ltd., 182, The Broadway, Wimbledon, S.W.19. 'Phone: Lib. 2814. [8241]

AMPLIFIERS, speakers, microphones, turntables and converters for hire and repairs departments.—Easco, 18, Brixton Rd., S.W.9. 'Phone: Rel. 1693. [0643]

TWO E.S. 250-watt Rack Amplifiers, 60 watts undistorted; 2 B.T.H. table microphones; 4 B.T.H. R.K. loud speakers, twin turntable and pick-ups, in working order, with spare valves.—R. Steel, 360a, Leith Walk, Edinburgh, 6. [8716]

CABINETS

OCCUPY Your Mind in the Blackouts!

BUILD Your Own Radiogram.—Marvellous 7-gn. cabinets from 25/-—Particulars Cameco Co., 23, Denmark St., W.C.2. Tem. 5900. [8717]

L.R.S. EASY TERMS
The oldest continuous Radio Service

—and still carrying on!

This is the easiest and most convenient way to possess any of the famous

ARMSTRONG CHASSIS

—at pre-war prices—

(See Armstrong advertisement p. 14)

The unusually high standard of quality and consistency of performance is universally recognised as an established feature of Armstrong Chassis. Whether on Short, Medium or Long Waves they bring in the transmissions with sparkling realism and a minimum of background.

ORDER NOW BEFORE PRICES RISE!

Illustrated literature giving full particulars of all models will be sent free upon request, with details of our convenient terms.

In addition to the Armstrong range, we shall be glad to quote for all other high grade equipment, such as Sound Sales Amplifiers, Voigt Speakers, Haynes Radio, Avometers, and **PORTABLE A.R.P. RECEIVERS**

Emergency Address:

LONDON RADIO SUPPLY COMPANY
"DENWYN," OXENDEN WOOD RD., CHELSFIELD, KENT

Relax and let yourself go!



● Illustrated is a Home Constructor's Corner Horn with Bass Chamber.

THERE'S a world of wisdom at this time in the somewhat slangy words of the popular song.

Have you heard first-class modern records through suitable gear terminating in a "VOIGT" Loud-speaker?

Try it, it's a marvellous mental tonic!

2 watts is enough for the home. For the informal dance, or the Works Canteen, a modest 10 watt amplifier is quite adequate, owing to the high efficiency of the "Voigt" Loudspeaker.

Prices from
£17-5-0 to £50

VOIGT PATENTS LTD.

THE COURTS · SILVERDALE · LONDON · S.E.26

Telephone: SYDenham 6666

Regd. Office: 22, Castle Street, London, E.C.1

CABINETS

A CABINET for Every Radio Purpose.

CONVERT Your Set into a Radiogram at Minimum Cost; surplus cabinets from noted makers under cost of manufacture (undrilled); 30/- upwards; motors at wholesale prices.

"FIT-A-GRAM" Cabinet, 31x17x15, 21/-.

UNDRILLED Table Console and Loud-speaker Cabinets from 3/6.

INSPECTION Invited; photos loaned to country customers.

H. L. SMITH and Co., Ltd., 289, Edgware Rd., W.2. Tel.: Pad. 5891. [0485]

NEW MAINS EQUIPMENT

VORTEXION Supply G.P.O., B.B.C., I.P.T.B. Why not you?

ALL Models Super Shrouded, primaries screened and tapped, 200-250v., filaments C.T.

ANY Model Fitted 5v. or 6.3v. Filaments if Required.

500—0-500 150 m.a., 4v. 4a., 2.5a., 4v. 2a., 4v. 2a., 4v. 2a., 35/-; 400 or 350v., same price.

500—0-500 120 m.a., 4v. 4a., 4v. 2.5a., 4v. 1.2a., 4v. 1.2a., 28/-; 400v. or 450v., same price.

425—0-425 150 m.a., 4v. 2-10a., 4v. 2.5a., 4v. 1a., 4v. 1a., 32/-.

350—0-350 120 m.a., 4v. 4a., 4v. 2.5a., 4v. 1.2a., 21/-; with extra 4v. 6a., 25/-.

350—0-350 75 m.a., 4v. 2-4a., 4v. 1-2a.; 18/-.

250—0-250 60 m.a., 4v. 2-4a., 4v. 1-2a.; 15/-.

AUTO Transformers, 100-120 to 200-240v., 80 watts, 11/-; 120 watts, 14/6; 200 watts, 21/-; 250 watts, 25/-; 300 watts, 28/-; 500 watts, 47/6.

W.W. Q.A. Output Transformer; 21/-.

MICROPHONE Transformers, in heavy magnetic shielding; 12/6.

CHOKES.—30h., 60 m.a., 7/6; 7-13h., 120 m.a., 12/6; 30h., 150 m.a., 15/-; 25h., 150 m.a., 21/-.

TRANSFORMERS and Chokes to Any Specification.

CAR Battery Charger, 6 and 12v., 1½ to 2 amperes; 30/- complete.

VORTEXION, Ltd., 182, The Broadway, Wimbledon, London, S.W.19. Telephone: Liberty 2814. [8715]

DYNAMOS, MOTORS, ETC.

ALL Types of Rotary Converters, electric motors, battery chargers, petrol-electric generator sets, etc., in stock, new and second-hand.

A.C.-D.C. Conversion Units for Operating D.C. Receivers from A.C. Mains, 100 watts output, £2/10; 150 watts output, £3/10.

WARD, 46, Farringdon St., London, E.C.4. Tel.: Holborn 9703. [0518]

DOUGLAS No. 3 Coilwinder, paper insertion attachment and motor, as new, cost £50; offers.—Raeburn, 21, Kilmailing Rd., Glasgow. [8234]

A.C. and D.C. Motors from 19/6; new and second-hand, guaranteed; also repairs department.—Easco, 1-3, Brixton Rd., S.W.9. Phone: Reliance 1694. [0644]

NEW LOUD-SPEAKERS

BAKERS' Brand New Surplus Speaker Bargains.

£8 Only.—Usual price £16; brand new corner horn speakers in beautifully finished polished walnut corner horn cabinet, frequency range 30-12,000 cycles, amazingly realistic reproduction.

£3/10—Usual price £6; brand new Baker super power electro magnet speakers, as solely specified for the "Wireless World" Quality Four receiver.

45/-—Usual price £4/10; brand new Bakers' super power permanent magnet speakers, exceptional bargain.—Bakers Selhurst Radio, 75, Sussex Rd., South Croydon. [8725]

LOUD-SPEAKER CONVERSIONS

BAKERS' Triple Cone Conversions Will Immensely Improve Reproduction and Increase Frequency Range of Your Present Speaker, whether electro or permanent magnet, any make, British or American; enables you to bring your speaker right up to date and obtain really realistic reproduction at the cost of a few shillings; free descriptive leaflet from the Pioneer Manufacturers of Moving Coil Speakers since 1925.—Bakers Selhurst Radio, 75, Sussex Rd., South Croydon. [8724]

YOUR BLACKOUT NIGHTS WILL BE FULL OF INTEREST IF YOU HAVE THIS ALLWAVE ALLWORLD EDDYSTONE RECEIVER

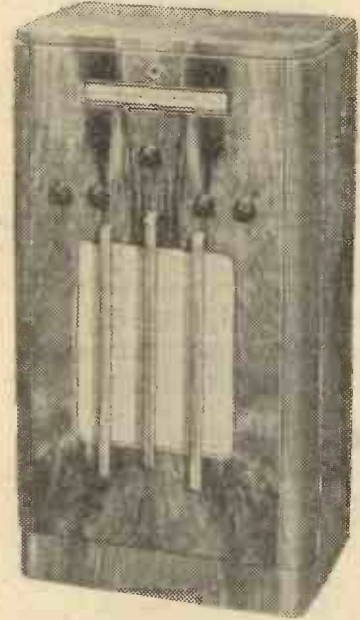

No longer will you be restricted to Local programmes—if you install this thrillingly interesting "EDDYSTONE" Seven-valve All-wave All-world Receiver. Each evening you'll come home to an ever-changing interest—a never-fading appeal—that will rob long evenings of their present dullness and invest them instead with recreational delight.

This "EDDYSTONE" Seven-valve Mains Receiver will give you HIGHLY INTERESTING WORLD-WIDE RECEPTION. It has four wavebands, i.e., 13-33 metres, 31-85 metres, 200-555 metres, and 900-2,100 metres. On the short wavebands you will ALWAYS find unlimited interest—something EXTRA—news from all countries of world events, interesting official and other communications, American amateurs, etc. Features of this outstanding set are special chassis and special coil unit construction, Automatic volume control, special intermediate frequency stage, H.F. amplifier, "Magic Eye" for accurate tuning, separate oscillator valve to eliminate frequency drift, tone control output, power pentode valve giving 5 watts undistorted output, 12in. loud speaker, gramophone pickup, and external speaker terminals.

Chassis and Moving Coil Speaker - - 21 Gns
In Magnificent Oak or Walnut Cabinet - 25 Gns.

GET IN TOUCH NOW WITH

STRATTON & Co., Ltd.

Eddystone Works, Bromsgrove Street, Birmingham.
OR SERVICE DEPOTS

WEBB'S Birmingham: 133 New St., 41 Carrs Lane & 123 Shirley Rd. London: 14 Soho St., W.1

COMPONENTS—SECOND-HAND CLEARANCE, SURPLUS, ETC.

(Continued from first column.)

WEARITE H.F. Chokes, screened; 1/6 each.

PENTODE Speech Transformers; 2/- each.

PLESSEY Dry Electrolytics, can type, 12 mfd. x 6 mfd., 500v. wkg., 1/6 each; 12 mfd. x 16 mfd., 350v. wkg., 1/6 each; 12 mfd. x 8 mfd., 500v. wkg., 1/6 each; 16 mfd. x 8 mfd., 475v. wkg., 1/6 each; 6 mfd. x 6 mfd., 500v. wkg., 1/6 each; 12 mfd., 450v. wkg., 1/6 each; 8 mfd. x 8 mfd. x 8 mfd., 500v. wkg., 2/11 each; 16 mfd. x 8 mfd. x 4 mfd., 500v. wkg., 2/11 each; 12 mfd. x 8 mfd. x 8 mfd. x 8 mfd., 500v. wkg., 2/11 each; 16 mfd., 450v. wkg., 1/3 each; 16 mfd. x 16 mfd., 350v. wkg., 1/6 each.

B.I. Cardboard Electrolytics, wire-end type, 500 volt wkg. 600 volt surge 8 mfd., 2/- each; 8 mfd. x 8 mfd., 4-lead type, 3/- each; 8 mfd. midget tubular wire-end 500 volt working 600v. surge, 2/- each; bias wire-end type, 25 mfd. 50 volt, 1/6 each; 50 mfd. 12 volt, 1/3 each; 50 mfd. 25 volt, 1/9 each; 25 mfd. 25 volt, 1/6 each.

TUBULAR Wire-end Non-inductive Paper, all sizes up to 0.1, 5d. each, 4/9 doz.

METAL Case, 1-hole fixing electrolytic condensers, 500 volt working, 600 volt surge, 8 mfd.; 2/6 each.

STANDARD Telephone Headphones, resistance 2,000 ohms and 4,000 ohms.; 6/11 per pair.

VOLUME Control, 1,000 and 5,000 ohms only, with switch; 1/3 each.

0.0005 3-gang Tuning Condenser, with trimmers; 2/11 each.

PLESSEY P.M. Bin. Moving Coil Speakers, with pen-trans., 1/6 each; less pen-trans., 9/6 each.

PLESSEY Energised Speakers, 1,500 ohms field, 8 in., with trans.; 7/11 each. 10 in., 2,600 ohms field with transformer; 12/6 each. 6 in., 1,500 ohms and 2,500 ohms; 5/11 each. 10 in., 1,000 ohms do; 12/6 each.

RUBBER Grommets; 4d. per doz.

SPECIAL Offer—Raytheon No. 76 valves; 2/- each.

S.P.D.T. Switches; 1/1 each. D.P.D.F. twist switches; 1/3 each.

RAYTHEON First-grade Valves, largest stockists, all types in stock, including glass series, glass octal series, metal series, bantam series, single-ended metal series, and resistance tubes; all at most competitive prices; send for lists.

ALL Orders Must Include Sufficient Postage to Cover. Hours of business 9 a.m.-6 p.m. Saturdays 9 a.m.-1 p.m.

RADIO CLEARANCE, Ltd., 63, High Holborn, London, W.C.1. Telephone: Holborn 4631. [8737]

PREMIER RADIO.

PLEASE See Our Displayed Advertisement on page 9. [0488]

SOUTHERN RADIO'S Bargains.

ALL Articles Fully Guaranteed. Postage extra.

5/-.—Parcel of useful components, comprising condensers, resistances, volume controls, coils, wire, circuits, etc., etc., value 25/- 5/- per parcel.

10/-.—Parcel of useful components, comprising 100 articles, including electrolytics, valve holders, etc., etc., value 55/- 10/- per parcel.

21/-.—Small traders' parcel of components, comprising at least 150 articles, including 24 assorted tubular condensers, 24 valve holders, 36 resistances, 12 Mainsbridge type condensers, 6 electrolytics, etc., etc., value 85/- 21/- per parcel.

5/-.—Twelve Mainsbridge type condensers, 1-2 4 mfd.; 5/- per dozen.

7/6.—24 assorted tubular condensers, up to 2 mfd., 7/6 for 24; Telsen 3-range meters (volts and milliamps), 4/-; Morse spacers, 2/11.

BUZZERS, 1/6; crystal detectors, 2/-; crystal sets, 5/6; crystals, 6d.

2/6.—Ormond loud speaker units, 2/-; A.C. eliminator, with trickle charger, 3/6.

IN Spite of Increased Costs of Production, whilst our present stock lasts no increase will be made in prices. It is, however, advisable to buy now. Thousands of bargains for callers.

SOUTHERN RADIO, 46, Lisle St., London, W.C. Gerrard 6653. [8904]

AMBASSADOR Offer Two Bargain Clearance Lines.

6-VALVE 4-band A.C./D.C. Superhet Chassis and 10 in. speaker, E.F. stage; £5/17/6; (note, 6

5-VALVE 3-band A.C. Superhet Chassis and 8 in. speaker; £7/5.

CASH with Order; satisfaction guaranteed.

AMBASSADOR RADIO WORKS, Hutchinson Lane, Brighouse, Yorks. [8730]

ELECTRADIX

A.R.P. AND EXPERIMENTERS BARGAINS

MOTORS. All sizes from 1/40 h.p., 15/- i.h.p. D.C. Motors, 25/- MOTORS, MOTORS, MOTORS. Small and Medium. A large stock of really fractional horse-power motors have been released at bargain prices. 6 volts, 50 volts, 100 volts and 230 volts.

A.C. MAINS MOTORS. Enclosed, self-start on load. A.C. repulsion, 1/60 h.p., with pulley. Type 36, 1,500 revs., 18/6. Ditto, 1/16 h.p., G.E.C. 3,500 revs., 27/6. Induction 1/10 h.p., 2,500 revs., 35/- i.h.p., 1,425 revs., 49/-.

D.C. MAINS MOTORS. 1/40 h.p., 110 v. or 220 v., K.B. series, 1,750 revs., 15/-. Ditto, 1/40 h.p., G.E.C., 230 v. series, 2,000 revs., 18/-. Ditto, 1/12 h.p. Croydon 110 and 230 v. shunt, 30/-.

DIX-MIPANTA VEST POCKET TESTER. A versatile moving-iron multi-range meter for service on A.C. or D.C. THREE ranges of volts: 0-7.5, 0-150, 0-300. Used for MILLIAMPS, reads: 124 m.a. in black bakelite case, 2 1/2 x 2 1/2 in., with pair of test leads and plugs.



19/6

ELECTRADIX RADIOS WONDERFUL BARGAINS. Home Recording with the all-geared FEIGH Electric Recorder, Ball Bearing centre gear box and traverse rod. Is the lowest priced electric home recorder you can fit any gram. The set with Tracking Gear, Pick-off Arm and tone arm with diamond ear only, 21/6.



ACOUSTIC RECORDERS. Great Fun. Lasting Interest. Cost is low. New MIVOICE acoustic sets, complete outfits in carton de luxe, 16/-. No. 2 Mivoice, 10/6. Junior, 5/6.

ELECTRIC SOLDERING IRONS. Heavy workshop type. 125 watts, 220/250 volts, 6/6.

BELLS. G.P.O. type trembler Circular Desk Bell, with movement in gong, 1/8. Wall Bell, trembler, 2/6. Ditto, large size, 7/6. Large metal 12-volt single stroke Bella, 10/-.

MAINS BELLS. A.R.P. 220-volt Ironclad Trembler Alarm Bells, with 10-in. gong, outdoor type, listed, 80/-. Sale, 37/6. Single Bell Wire, 3/- 100 yards. Twin Bell Wire, 3/- 100 yards. Hoopers, 6 and 12 volts, 4/6. Bell Transformers for A.C. 100 volts, 2/6. 230 volts, 5/6 and 15/-.

MORSE PRACTICE SET. Sound Type No. 10, with Key and Buzzer on base, 3/- Visual Type No. 2A with Key and Lamp on base. No. 3A Duplex with Key and Buzzer and Lamp for sound and visual, line plug is on base, 7/-. BUZZERS from 1/- each.

YOU MUST KEEP YOUR BATTERY PREPARED 111. Battery Charging on A.C. Mains. The A.C. NITN-DAY will keep your battery fit without attention. Model N/A6, 100/250 volts A.C. and D.C. 6/8 volts 1 amp., 15/-. Model N/B6, 100/250 volts to D.C. 6/8 volts 1 amp., 25/-. Model N/C6, 100/250 volts to D.C., 6/8 volts 2 amp., 35/-. Model N/D12, 100/250 volts to 12 volts 1 amp., 32/-. Ditto, 12 volts 2 amp., 50/-. Model N/E6, 5 amp., 42/10/-.

WARTIME ELECTRIC SUPPLY. An Independent Emergency or Stand-by set may be of great value to you. Can be transported on any car that can carry 3-cwt. All these sets that we are offering are in first-class order and straight from reserve Govt. Stores, kept unused as stand-by. Being a pre-crisis release they are an opportunity for a low price purchase that might not otherwise have occurred and certainly cannot be repeated. The Half Kilowatt set is worth £40, but our price is only £16, and with engine and dynamo carry the full Electradix guarantee.

A.R.P. PETROL ELECTRIC GENERATING SETS FOR LIGHTING AND CHARGING FOR £16 ONLY.

A 500 watt, single cyl., 2-stroke, water-cooled, self oiling Stuart Turner engine; mag. ign. coupled to 50/70 volts, 10 amps. shunt dynamo, 1,000 r.p.m. £16. No increase in price, these are £40 sets ready for immediate delivery.

FOR £12. A 150 watt engine and dynamo on similar lines but coupled to 25/30 volts, 6 amps. dynamo. Half Kilowatt and other sizes; all ready for immediate delivery.

STORAGE. You may have charging facilities and want to install high capacity steel accumulators which will hold their charge almost indefinitely.

A.R.P. EDISON HIGH CAPACITY STEEL CELLS at half price for stand-by lighting, 120 A.H. to 300 A.H. at 20/- to 25/-. Makers' Price is 45s. Ask for leaflet. FULL PARTICULARS gladly given as far as we are able to A.R.P. ENQUIRIES.

A.R.P. ACCUMULATORS for stand-by H.T. at 6d. per cell; 3 amp. hours. In 24 volt unit rates, glass cells, 12/- each. Can be parallel charged off 12 volts.

ELECTRIC IMMERSION HEATERS. Save coal. Armoured bath or tank type with flex, 1,000 watts 230 volts, 25/-. Fuzzy Dug-outs or ill-ventilated shelters must be kept fresh.

A.R.P. SHELTER Ventilation and Air Conditioning. Compact unit, drive off A.C. or D.C. mains, 80 watts; 9 in. Blower, 20 cub. ft. fresh air per min. 25/- is a bargain price.

WET WEATHER ELECTRIC PUMPS, for A.C. or D.C. 12 v. to 230 v. Centrifugal all-bronze pump, throws 120 gals. per hour, 72/6. Type B pumps, Twin piston type for draining shelters, dug-outs, etc., £6/17/6.

RADIO SIGNAL PHONES. Complete sets with 5 line or 20 line exchanges.

Portable army warden's phones, etc. State wants.

POCKET HEADPHONES. W.D. all leather headband, strap and cords, 2/6 pair. Wireless type, with aluminium headbands, 2/9. 4,000 ohms, 4/6, 6/6 and 8/6.

LISTENING MIKES, steel clad Electradix, indestructible; are ears outside your dug-out.

CABLE. Lightweight twin field cable, unbreakable Army steel reinforced, 55/- mile. Heavier types, 65/- and 70/-.

FIRE CONTROL SIGNALS. Emergency day Lucas and Aldis Hooped Army Signal Lamps, telescopic sights, hand or tripod. For Fire Brigades and Police, 60/-. AIR RAD SIGNAL BELLS—FIRE ALARM BELLS. Waterproof mains, Battery or Hand magnet Buzzer; Morse Practice Sets. Morse Keys. Recorder gear, as previous advert.

5/- EMERGENCY PARCELS of useful stand-by electrical and radio repair material and apparatus, 10lbs. for 5/-. Post Free.

Don't forget to send for latest Bargain List "W."

ELECTRADIX RADIOS

218, UPPER THAMES STREET, LONDON, E.C.4

Telephone: Central 4611

TRANSMITTING APPARATUS

G5NI for Communication Receivers, American and British valves, short-wave equipment; largest stocks in the country; National Agents.—44, Holloway Head, Birmingham. [0531]

VALVES

ALL Types of American Tubes in Stock of Impex and Arcturus makes at competitive prices. WE Can Also Supply a Full Range of Guaranteed Replacement Valves for Any British non-ring. American or Continental type at an appreciably lower price.

SEND for Lists of These, and also electrolytic condensers, line cords, resistances, etc. CHAS. F. WARD, 46, Farringdon St., London, E.C.4. Tel.: Holborn 9703. [0452]

METROPOLITAN RADIO SERVICE.—American valves, in all types, trade supplied.—1021 Finchley Rd., N.W.11. Speedwell 3000. [0436]

TEST EQUIPMENT

ALL-WAVE Battery or Mains Oscillator; lowest price.—Broomfield, Radio Centre, Usk. [8715]

MULTIRANGE A.C.-D.C. Testers, 1,000-25,000 o.p.v., employing Ferranti and 4 1/2 in. square, large-scale meters; very limited number still available at pre-war prices, in kit form or assembled and tested.

KITS (Any Ranges) Supplied to Suit Client's Own Meter, also all meter and bridge components.

WE Specialise Exclusively in Service and Laboratory Apparatus, and invite enquiries for kits or complete instruments.—L. A. MacLachlan and Co., Instrument Makers, Strathely, Scotland. [8721]

Wanted

WANTED, signal generator, meters; particulars and prices to: Taheny, Market St., Sligo, Eire. [8735]

COMPONENTS SECOND-HAND, CLEARANCE, SURPLUS, ETC.

R. RADIO CLEARANCE, Ltd.

63, High Holborn, W.C.1. 'Phone: Holborn 4631.

BRITISH Belmont 8-valve plus Magic Eye All-wave A.C. Superhet Chassis, 6 wavebands, two short, medium and long, fitted latest Mullard octal base American type valves, size of chassis 13 1/2 in. x 10 in. x 3 in., supplied with valves, escutcheon and knobs, but less speaker; chassis only, £5/19/6 each; speaker for above, 17/6 each.

FILAMENT Transformers, input 200-250 volts, output 4 volts 4 amp., 4 volts 6 amp.; 4/11 each.

MAINS Transformers, American windings, input 200-250v., tapped, output 350-350 100 m.a., 5 volts 2 amp., 6.3 volts 5 amp.; 8/6 each.

G.E.C. Mains Transformers, American windings, 350-0-350v. 65 m.a., 5 volts 2 amp., 6.3 volts 2.5 amp., suitable for replacements in G.E.C. chassis, 5/6 each; Auto transformers, 100-250 volts, 6/3 each.

24 MFD. Cat. Type Electrolytics, 450 volts working; 1/6 each.

T.C.C. 8 Mid. Can Type Wet Electrolytics, 450v. working; 1/3 each.

PRESS Button Units, with 6 press buttons, ready for wiring into set, with circuit; 6/11 each.

BULGIN 20 Ohms. Wire Wound Pots; 1/- each.

STRANDED Push Back Wire, 1d. per yard, 12 yards 10d.

CHASSIS Mounting Valve Holders, American, 4-, 5-, 6- and 7-pin; 4d. each.

OCTAL, 5d. each; Octal, 10d. each; 7-pin English type, 3d. each.

ROTHERMEL Piezo Crystal Speakers, 7 1/2 in. cone; list 55/-, our price 10/6 each.

CRYSTAL Pick-up, high grade American bronze finish, complete with arm; £1/5 each.

POLAR N.S.P. 1 Watt Resistances; 4d. each, 3/9 doz.; all sizes up to 2 meg.

WEARITE Mains Transformers, made to strict electrical standards, wire-end type, all windings centre tapped, screened primaries, tapped inputs 200-250 volts, screw adjustment.

TYPE R.C.2 350-0-350, 120 m.a. 4 volts, 2.5 amps., 4 volts, 5 amps., 11/- each.

TYPE R.C.4 500-0-500, 150 m.a. 4-volts, 2 amps., 4 volts, 2 amps., 4 volts, 2.5 amps., 4 volts, 5/6 amps; 19/6 each.

TYPE R.C.2, drop-through type, capped.

TYPE R.C.4, upright mounting type, fully shrouded.

AMERICAN C.T.S. Volume Controls, finest made, divided spindles, length 2 1/2 in., with switch, 2,000, 5,000, 10,000, 25,000, 50,000, 100,000, 2/6 each; less switch, 50,000, 100,000, 500,000, 1/9 each; wire wound 5 watt (less switch), 2,000, 10,000, 25,000, 50,000, 2/- each.

BRADLEY Ohm Wire Wound Volume Controls, with switch, 600,000 ohms; 1/- each.

(Continued in third column.)

COMPONENTS—SECOND-HAND
CLEARANCE, SURPLUS, ETC.

RYALL'S RADIO, 280, High Holborn, London, W.C.1, offer new goods, post free.

ELLIPTICAL Speakers, Celestion, suitable Ekco replacements, 750 and 1,250 ohms. Less transformers, speech 25 ohms, new, handle 8 watts, carry up to 120 m.a.; 3/9 each to clear.

SPEAKERS, pairs, brand new, elliptical cone speakers, made by first class firm, quality of reproduction outstanding, push-pull pentode transformers, fields 325 ohm for smoothing choke, 8,600 as bleeder, circuit available, handle 10-15w.; 14/- pair.

HEAVY Duty Mains H.F. Chokes, Goltone, 75w. high inductance type, 1/6; 180w. low inductance type, 1/-.

MAINS Transformers, drop through chassis type, top cover with mains adjustment, input 200.250v., outputs 350-350, 80 m.a. 4v. 2½a., 4v. 4.5 amp., heavy jobs, 6/9 each.

MAGNAVOX 7in. Cone Speakers (8in. overall), ribbed pattern, ideal replacement speakers, 2,000 ohms pentode transformers; 7/- new.

SATOR ½meg. Pots with Switch, 1/3 each, 7/9 dozen; 10,000 ohm broad base tone control type, less switch, 1/3 each, 6/9 dozen

ZENITH Insulated A.C.-D.C. Resistances, 0.3 amp., 550 ohms, tapped 380-100-70, ex-Ferranti, 1/3 each; ditto, 670 ohms, tapped 500-70-30 ohms, 1/9 each, 6 for 9/-; ditto, 150 ohms, tapped, 1/3 each; all insulated types.

ELECTROLYTICS—Six for 9/-; size 4¼in. x 1¼in., B1, 20x20 mf. at 350v., 25x25v., 1/3; size 3in. x 2¼in., B1 2x2x2, 400v. peak, 1/3 each, 9/- dozen; 25x25v., 1/3; Plessey 30x8x2, 300v. wkg., 1/6 each, 12/- dozen.

B.1 0.05 Condensers, N.1. 350v. wkg., 1/3 dozen, 9/- gross; B.1 0.25 condensers, 350v. wkg., 2/- dozen, 4/6 per three dozen, tubulars.

SATOR 1,500v. Test Tubular Condensers, assorted, equal numbers, 0.0002-3.5, 0.001, 0.03, 0.05, 0.002-3, mica; all at 50 for 2/6

ASSORTED Resistances, 50 for 2/6; 1-watt carbon, U.S.A. make, reasonable assortment given, sizes approx. 450-12,000-17-60-90-120 thousand ohms.

PUSH Back Wire, 18g., 50 yards, 3/6; Systoflex 1½ mm., ½ gross, 5/-; twin screened 2x14-36, British made, 12 yards, 2/6; minimum quantities.

REX Type Switches, 4B, 2P, 4w., with shorting plate on 5 switches, 2/6 each, length 7in., spindle 2in.; ditto, 3w. 4P, 3B, 1/6; 3w. 3P, 3B., with shorting plate, 1/6; 3w. 2P, 4B., 1/6; any combinations of this item supplied; screens, 3in. x ½in. x 3in. x ½in., 5 for 1/3.

EPICYCLIC Drives, Polar ex-Ferranti, long spindles; 1/3 each, or 21/- per 100, minimum, all new.

POLAR V.P. Drives, less escutcheons, 1/9; Plessey 2-gang fully screened condensers with top-trimmers, short spindles, 2/9 each, or 20/- per dozen.

TRIMMERS on Porcelain Plessey, double and single, 50-100-200-160 ohm. approx.; 50 for 2/6; special price quantities.

APPROX. 800 Cossor 3-gangs, 600 Plessey 3-gangs, 8,000 Missner double trimmers for I.F.s and 8,000 alni I.F. cans to fit, approx. 2,000 Ferranti screened grid coils, and 3,000 aerial transformers.

HAMMERLUND 30mm. Midget Trimmers on Pazo-lin, 1/9 dozen; ultra type brown knobs, octangle, plain arrow, L.S. 1/9 dozen, 8/6 gross assorted, 10/6 gross plain or arrow.

SMALL Iron Core Coils, made by Varley, aerial and oscillator, 465 k/c, 2/6 pair, with coil connections for straight type gang.

SPECIAL Offer, 2v. valves, similar to Triotron, HD2, SD2, TD2, ZD2, UD2, all 2/- each, new; also type 46 U.S.A., 3/6, A.C. Class B.

MAGIC Eye Valves, 6G5, 2/9; or British type 4v. ½ amp., octal base, 3/6; 2-speed 4-band dials, ex Berners, 2/6 each, less escutcheon.

PLESSEY 6,500 ohm. 8in. Speakers, with pentode transformer, 6/6; U.S.A. valve screens (goat), complete, 3 for 1/4.

SCREENED Leads about 4 yards, 3-way, two only screened, 1/3; extra heavy for car sets, with spades, 1/3, 2/4 yards.

COLOUR Coded 1-watt Resistors, best known make, sizes in ohms, 100, 200, 350, 400, 450, 700, 1,000, 2,000, 3,000, 5,000, 7,500, 10,000, 20,000, 25,000, 30,000, 50,000, 60,000, 100,000; ¼ meg., ½ meg., 1 meg.; 3/3 dozen. [8894]

COULPHONE RADIO, Ormskirk, for value and service; full trade discounts on Collaro, Gramophone Motors, Champion and Record Valves; high quality, 20-watt amplifiers, £10/10; 1¼d. stamp for 1940 catalogues.—Phone: 578. [8710]

"H.A.C." one-valve Short-wave Receiver, famous for over 5 years, now available in kit form; complete kit of precision components, accessories, full instructions, 12/6, post 6d., no soldering necessary; descriptive folder free on request.—Bacchus, 109, Hartington Rd., S.W.8. [8720]

BANKRUPT Bargains—Brand new 1938-9 models, makers' sealed cartons, with guarantees, at less 40% below listed prices; also portables and midget radio; send 1¼d. stamp for lists.—Radio Bargains, Dept. A.W., 261-3, Lichfield Rd., Aston, Birmingham. [8733]

CHASSIS
Special "Replacement" Offers
5-V. ALL-WAVE R/Gram S/Het
Complete with all valves.

Carr. Paid. £5:19:6
Fully tested.

NEW SEASON'S 6-stage 5-valve chassis. Wave-range 15-2100 metres. A.V.C. Tone and Volume controls. Pleasing station-name illuminated scale. 3-watts output. Pick-up sockets. Size 11" wide, 9" high, 8" deep. Fully tested, ready for use on AC or DC supplies 200/250 V. Fully guaranteed.

SPEAKER. Matched 1600 ohms energised speaker for above, 27/6 extra.

BATTERY 7-STAGE S/HET. All-wave manual and Broadcast Press-button tuning. Station and metre calibrated scale and size, as illustrated above. 4 valves with Pentode output, providing an unsurpassed performance with ample volume. Complete with all valves, fully tested. Price £6:2:6. Matched P.M. speaker 25/- extra.

AC MAINS VERSION OF ABOVE. Recommended replacement model for All-World Listening and Broadcast Push-button tuning. For AC 200/250 v. Price £7:12:6. Matched 2500 ohms speaker £1:7:6 extra.

AC 4v. ALL-WAVE S/HET. Special offer which should not be missed. Wave-range 15-2100 metres. Circuit comprises VM triode hexode, HF Det. Pent., steep slope output Pent. and Rectifier. Illuminated station and metre scale. Output 3 watts. Size 11" wide, 9" high, 8" deep. Complete with all valves, fully tested. Price 79/6. 2500 ohm matched speaker 27/6 extra.

AC 4-V. S.G. BANDPASS. Ideal for emergency or general use. Wave-range 200-2,000 metres. Excellent performer. Illuminated scale. P.U. sockets. 3 watts output. Special offer, complete with 4 valves, fully tested, 61/6. 2500 ohm speaker 27/6 extra.

BATTERY CLASS "B" 4. Another special offer for general or emergency use. Wave-range 200-2,000 metres. Excellent tone and volume. Complete with 4 valves, fully tested. Price 61/6.

● All above chassis, except first offer, available less valves.

AMPLIFIER. Battery 4 watts model. 4-valves with push-pull output. In chassis form with provisions for mike or grammo. use. Requires for use, 2 v. LT and 130-150 v. HT batteries. Ready for use. Price 59/6.

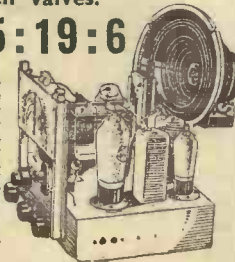

PETO-SCOTT CO., LTD.
77, (W.W.M.) City Rd., London, E.C.1, and 41, High Holborn, W.C.1.
Tel.: Clissold 9875 or Hol. 3248.
See TROPHY announcement on Contents Page.

CLIX
SAFEWAYS ADAPTORS

You can use your Radio and other electrical appliances in any room and serve their full benefit throughout your home by fitting a SAFEWAYS Adaptor in your existing lampholders. To nullify the depressing effects of the "Black-out" fit a SAFEWAYS adaptor with a low-wattage lamp in the branch outlet and the usual lamp in the other. You can then enjoy normal lighting knowing that, should it be necessary, dimmed lighting can be switched on at a moment's notice.



This particular arrangement can also be used as a night-light for children or invalids, but is merely one of many ways in which SAFEWAYS can increase the convenience of your electrical installation—quickly, cheaply and safely.

ASK YOUR DEALER for "SAFEWAYS"
Single Switch, 1/10; Double Switch, 2/3;
Cord Control 2/6 each.

A CLIX product made by—
BRITISH MECHANICAL PRODUCTIONS LTD.,
1, Church Road, Leatherhead, Surrey

COMPONENTS—SECOND-HAND
CLEARANCE, SURPLUS, ETC.

VAUXHALL—Collaro A.C. gramophone motors, boxed, 29/-; flat sheet aluminium 12x12in., 3/-; 18x18in.; 5/6.

VAUXHALL, P.C.C. aluminium containers, 8 mfd. 500v., 2/9; T.C.C. cardboard containers 8 mfd., 600v., 2/-; 8 & 8 mfd., 3/6.

VAUXHALL—Iron-cored coils on base with switch, terminals, circuit; 2-gang 12/6, 3-gang 19/6.

VAUXHALL—Metal rectifiers H.T.10, 11/-; H.T.9, 9/-; Hivac valves and reliable American types.

VAUXHALL—Rola G12 P.M. speakers, 69/6; G12 energised, 55/-; brand new and complete input transformer.

VAUXHALL—Rola 8in. P.M. speakers, 14/9; 10in. energised 2,500, 19/9; all complete with input transformer.

VAUXHALL—Electrolytic condensers, 50 mfd. 50v., 1/9; 50 mfd. 12v., 1/6; 0.1 mfd., 3d.; 0.25 mfd., 4d.; tubulars.

VAUXHALL—Polar 4-gang straight 0005 mfd. condensers, 13/6; Clix chassis valveholders, 5-pin, 5d.; 7-pin, 6d.; resistors, one-watt, 4d.

VAUXHALL—Three band 2-gang coils for mains superhet, base, terminals, switch, 18/-; volume controls 2/-, with switch 3/-.

VAUXHALL—J.B. bar-type condensers, 3-gang 8/6, 2-gang 7/-, straight type J.B. full vision drives 6/-.

VAUXHALL UTILITIES, 163a, Strand, London, W.C.2. Write for free list. [3728]

MAINS RADIO DEVELOPMENT Co., continue their super service under management of proprietor's wife.—Note new address, 52a, Church Crescent, Muswell Hill, London, N.10.

ERIE Unused One Watt Resistors, all sizes; 4d. each, 3/6 dozen; Two-watt 7d.

CENTRALAB Latest Potentiometers, long standard spindles, all sizes; 2/6, with switch 2/9.

CLIX Latest Chassis Mounting Valve-holders, English 5, 7-pin, American, all sizes; 6d. each. Standard sleeving 1¼d. yard.

DUBILIER Unused Mica Condensers, midget type; 0.00005 to 0.0005 mfd. 3d. each, 2/9 dozen.

T.C.C. New Tubular Wire End Condensers, 350v. working, 0.001 to 0.05 mfd., eight useful sizes in each parcel; 12 condensers 2/-, 25 for 3/9.

N.S.F. Wire End Resistors, unused, eighteen useful marked and colour coded sizes in each parcel of 50 resistors for 3/-.

TUBULAR Condensers, new, 400v. working, wire ends, non-inductive, best make, all sizes; 0.0001 to 0.1 mfd. 4d. each.

BULGIN Rotary Toggle Switches, on-off, unused; 10d. T.C.C. metal can, dry, 8 mfd., 525 volt electrolytics; 3/- Dubilier 4 mfd., 250 volt electrolytics; 10d.

MAINS RADIO DEVELOPMENT Co's List 231 Contains Many Fins Bargains. Send stamp. [8909]

Wanted
WE Buy for Cash All Types of Modern Second-hand Radio Sets and Accessories, test meters, parts, etc. We pay more than any other dealer. Part Exchanges. Bring, send or will call.—University Radio, Ltd., 238, Euston Rd., London, N.W.1. Phone: Euston 3810. [8908]

MISCELLANEOUS
A.R.P.—Emergency electric lighting; engine electric sets, 500 watts, £16; 150 watts, £12; details on request; wardens' exchanges. Telephones, wire, cables, etc., for shelters, 72/6; motor pumps, 25/-; exhaust fans, 25/-—Leslie Dixon Co., 218, Upper Thames St., London, E.C.4. [8712]

EVERY Radio Dealer Who is Not a Regular Reader of "The Wireless and Electrical Trader" should send his trade card at once for a specimen copy and full details of the "Trader" Services. "The Wireless and Electrical Trader" has the widest influence, the largest weekly circulation, and is read by all the leading manufacturers and traders. Trade only. 15/- per annum, post free.—Published at Dorset House, Stamford St., London, S.E.1. [0615]

REPAIRS AND SERVICE
L.S. Repair and Rewinding Service—Prompt service, see below.
REPAIRS to Moving Coil Speakers a Speciality, new cone assemblies fitted, speech coils and fields wound or altered, mains transformers, chokes and eliminator repairs; prices quoted.
SPEAKER Transformers Class "B" L.F. transformers and pick-ups rewound at 4/- each. Post free. Discount trade. Estimates free. Guaranteed satisfaction.—L.S. Repair Works, 5, Balham Grove, London, S.W.12. Phone: Battersea 1321. [0394]

LOUD-SPEAKER Repairs, British, American, any make, 24-hours' service; moderate prices.—Sinclair Speakers, Putney Terrace, Copenhagen St., N.1. [0590]

GUARANTEED Repairs, any transformers, choke, motor armature, converter, dynamo, etc.; keenest prices, immediate quotation, prompt, dependable service.—See below.
L.T.P. (LONDON TRANSFORMER PRODUCTS, L.T.P. Ltd.), Willesden, N.W.10. Willesden 6486 (13 lines). [8892]

MAINS Transformer Service, repairs, rewinds, or competitive prices and prompt service.—Sturdy Electric Co., Dipton, Newcastle-on-Tyne. [0516]

REPAIRS & SERVICE

METROPOLITAN RADIO SERVICE.—Guaranteed repairs to American and British receivers; American valves, service parts and rewinds; trade supplied.—1021, Finchley Rd., N.W.1. Speedwell 3000.

CHALLENGER RADIO CORPORATION.—Repairers of British and American receivers to the trade; lowest prices with good workmanship; "service with a guarantee"; also speakers, transformers, coils, etc., rewound.—Challenger Radio Corporation, 31, Craven Terrace, Lancaster Gate, London, W.2. Paddington 6492. [8732]

SITUATIONS VACANT

AIR MINISTRY.

CIVILIAN Wireless Instructors Required.

VACANCIES Exist for Civilian Wireless Instructors at the Electrical and Wireless School, Royal Air Force. The commencing rate of pay is £4 a week inclusive, which may be increased to £4 5s. a week after a short period of satisfactory service. Candidates must be capable of lecturing and must have a sound knowledge of electrical principles and their application to Radio and low-power electrical engineering. Applications should be addressed to the Under Secretary of State, Air Ministry, Savoy Hill House (S.5.d.), London, W.C.2, giving full particulars as to previous experience, age, etc. Candidates will be required to appear before a Selection Board at the School, for interview and test. The test will include the giving of a lecture on any subject which may be chosen by the candidates, involving the principles of modern radio. Lecturing sequence and style are most important. [0571]

AIR MINISTRY.

DIRECTORATE or Communications Development.

APPLICATIONS are invited for Appointments as Assistant I at Air Ministry Headquarters for work in connection with communications equipment.

CANDIDATES Should Have Had a Good Education and experience of radio design, preferably in industry, in relation to planning for production.

SALARY £400 a Year (fixed rate).

THE Appointments will be Temporary and Non-pensionable.

REQUEST for the Necessary Application Form should be made by postcard, quoting Reference B.403, addressed to the Under-Secretary of State, Air Ministry, Dept. ZA (B127), Harrogate, Yorks. Closing date for receipt of completed application forms is the 27th October, 1939. [8711]

YOUNG Men with Experience of Wireless Operating.

REQUIRED for Three Years' Service as Constables in the Palestine Police Force; pay £11 a month (plus trade pay) of £3 per month when employed as wireless operators, uniform, rations and quarters; free passages and leave on full pay; candidates, age 22-28, must be single, of good physique and physically fit, and must hold a Postmaster-General's certificate in wireless telegraphy.—Apply, stating exact age, height and particulars of education and training, to the Crown Agents for the Colonies, 4, Millbank, London, S.W.1. Head your letter "Palestine Police". [8713]

RADIO Service Engineer, must be thoroughly experienced and conversant with American receivers.—Telephone: Speedwell 3000 for appointment. Metropolitan Radio Service, 1,021, Finchley Rd., N.W.11. [0645]

RADIO Engineer Required, fully experienced on transmitters and receivers, 1-5 metres; only men with first class experience need apply.—State age, salary and experience, to Box 1067, c/o The Wireless World. [8726]

RADIO RENTALS, Ltd., require immediately for all London districts and the provinces, expert service engineers, preferably with saloon cars; good pay and prospects.—Apply, by letter only, giving full particulars, age and experience, to Service Manager, Radio Rentals, Ltd., 11, Mattock Lane, Ealing, W.5. [8729]

VACANCIES Exist for Civilian Wireless Instructors at the Electrical and Wireless School, Royal Air Force. The commencing rate of pay is £4 a week inclusive, which may be increased to £4 5s. a week after a short period of satisfactory service. Candidates must be capable of lecturing and must have a sound knowledge of electrical principles and their application to Radio and low-power electrical engineering. Applications should be addressed to the Under Secretary of State, Air Ministry, Savoy Hill House (S.5.d.), London, W.C.2, giving full particulars as to previous experience, age, etc. Candidates will be required to appear before a Selection Board at the School, for interview and test. The test will include the giving of a lecture on any subject which may be chosen by the candidates, involving the principles of modern radio. Lecturing sequence and style are most important. [0616]

Printed in England for the Publishers, **LIFFE AND SONS LTD.**, Dorset House, Stamford Street, London, S.E.1. "The Wireless World" can be obtained abroad from the following: **FRANCE:** W. H. Smith & Son, 248, Rue Rivoli, Paris; Hachette et Cie, Rue Réaumur, Paris, and branches; Messageries Dawson, 4, Rue de Faubourg Poissonnerie, Paris. **BELGIUM:** W. H. Smith & Son, 74-75, Boulevard Adolphe Max, Brussels. **AUSTRALIA:** Gordon & Gotch, Ltd., Melbourne (Victoria), Sydney (N.S.W.), Brisbane (Queensland), Adelaide (S.A.), Perth (W.A.), and Launceston (Tasmania). **NEW ZEALAND:** Gordon & Gotch, Ltd., Wellington, Auckland, Christchurch and Dunedin. **INDIA:** A. H. Wheeler & Co., Bombay, Allahabad and Calcutta. **CANADA:** Imperial News Co., Toronto, Winnipeg and Vancouver; Benjamin News Co., Montreal; Gordon & Gotch, Ltd., Toronto. **SOUTH AFRICA:** Central News Agency, Ltd.; Wm. Dawson & Sons (S.A.), Ltd., Cape Town. **UNITED STATES:** The International News Co., New York.

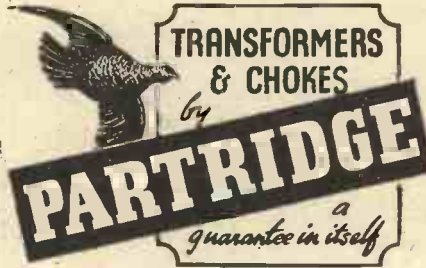

FOR A-R-P APPLICATIONS

Trench Lighting, Low Voltage Lighting for Workshops, Factories and Offices, also for use in P.A. Equipment; etc.

Priority must be given to Government requirements but good delivery is still being maintained to the private user.

N. Partridge
Kings Bldgs., Dean Stanley St.
LONDON S.W.1
Telephone: VICTORIA 5035

ENGINEERS!
ARE YOU EARNING LESS THAN £10 PER WEEK?

If so, you cannot afford to carry on without reading our 268-page Handbook. The book explains clearly and definitely many ways of carving out a successful career. Among other things it explains the Services of our unique Appointments Department: outlines Home-Study Courses in all branches of Civil, Mechanical, Electrical, Motor, Aero, Wireless, "Talkie" Engineering, Building, Govt. Employment, etc., and gives details of B.Sc., A.M.L.C.E., A.M.I.E.E., A.M.I.Mech.E., A.M.I.A.E.E., A.M.I.W.T., A.M.I.B.E., G.P.O., MATRIC, and all Exams. We Guarantee—"NO PASS—NO FEE." Whether you be an old hand or a budding apprentice get this book to-day. FREE and POST FREE.

BRITISH INSTITUTE OF ENGINEERING TECHNOLOGY,
367, Shakespeare House, 17/19, Stratford Place, London, W.1.

THE INSTITUTE OF WIRELESS TECHNOLOGY
(Founded in 1925. Incorporated.)
DECEMBER EXAMINATIONS
Applications will be accepted up to and including November 25th.

Application Forms and Syllabus may be obtained from the Assistant Secretary:—Institute of Wireless Technology, 25 Firs Drive, Palmers Green, London, N.13

Yachting World MONTHLY
and Power Craft 1/- W.W.

SITUATIONS VACANT

WIRELESS Technical Instructors Required in Army Units.

EMOLUMENTS. PAY 8/3 Per Day (7 Days a Week). Clothing, rations and accommodation, or if this cannot be provided, allowances at authorised rates. If married and otherwise eligible, family allowances payable in respect of wife and children subject to allotment from pay.

CANDIDATES Should Preferably be Under 35 and Over 24 and (A) Hold One of the Following Qualifications:—

GRADUATESHIP of the Institution of Electrical Engineers.

FINAL (Grade III) Certificate of City and Guilds of London Institute Examination in Radio Communication.

HIGHER National Certificate in Electrical Engineering.

CERTIFICATE of City and Guilds of London Institute in Radio Service Work.

OR Similar Qualifications.

OR (b) Be Able to Pass an Examination on the Following Syllabus:—

CURRENT Electricity.—Properties of an electric current; Ohm's law and its applications; galvanometers and measuring instruments; electro-magnetism; magnetic materials; conductors, insulators and dielectrics.

ALTERNATING Currents.—General principles; effects of resistance, inductance and capacity; resonance.

RADIO.—General character of a radio signal; knowledge of valves and their simple applications; general knowledge of tuning both transmitters and receivers.

MATHEMATICS.—Knowledge of algebra and simple Trigonometry.

SUITABLE Candidates will be Interviewed at Local Centres, and, if successful, will be enlisted and appointed acting Sergeant-Tradesman. For those who are on the Schedule of Reserved Occupations special arrangements will be made to enable them to be enlisted.

APPLICATION Forms, obtainable by postcard from the Under Secretary of State, War Office (T.O.1), Whitehall, S.W.1, to be lodged by 6th November, 1939. [8736]

TECHNICAL TRAINING

BEST Wartime Training in Engineering is Home Study with the T.I.C.B., free from black-out and travel difficulties; trained men are urgently required for well-paid technical posts in all branches and in the Services.—Write to-day for "The Engineer's Guide to Success"—free—containing world's widest choice of engineering courses—over 200—covering all branches. **THE TECHNOLOGICAL INSTITUTE OF GREAT BRITAIN,** 82, Temple Bar House, Fleet St., E.C.4. (Founded 1917. 20,000 Successes.) [8722]

PATENT AND TRADE MARK AGENTS

GEE and Co. (H. T. P. Gee, Mem. R.S.G.B., etc.), 51-52, Chancery Lane, London, W.C.2. Holborn 4547-8. Handbook free. [0001]

PATENTS

"**PRACTICAL** Hints on Patents," free on application.—The Imperial Patent Service, First Avenue House, High Holborn, W.O.1. Preliminary consultation free. [0481]

TUITION

RADIO Training.—P.M.G. exams and I.E.E. Diploma; prospectus free.—Technical College, Hull. [0611]

PRACTICAL Postal Courses, radio television; test equipment design; I.P.R.E. and I.W.T. exams.—Write I.P.E., 3, Shirley Rd., London, W.4. [8838]

BUSINESS & PROPERTY FOR SALE, TO BE LET, OR WANTED

"**THE** Wireless and Electrical Trader" is an essential part of the equipment of every Wireless Trader; its pages reflect the very latest turn of trade events, and it is read by all the leading dealers and manufacturers, for particulars of businesses offered or wanted. By subscription to the trade only, 15/- per annum, post free.—Send your trade card for specimen copy to Dorset House, Stamford St., London, S.E.1. [0614]

BOOKS, INSTRUCTION, ETC.

DIVERSION.—Unorthodox theory, detector circuits, experiments; book 2/-.—D'Arcy Ford, Gandy St., Exeter. [8707]



SHERLOCK HOLMES says...

*"If it's electric
test it with a
PIFCO"*



Don't waste time over testing electrical appliances. The Pifco Rotameter will do it for you, swiftly, surely, and with the minimum of trouble. Whether you're an amateur or an expert, it will enable you to trace faults immediately in radio sets, bells, or anything electrical. It is made from the finest of materials: designed for durability and absolute precision.

EIGHT RANGES:

- 0-5 volts
- 0-20 volts
- 0-100 volts
- 0-400 volts
- 0-10mA
- 0-50mA
- 0-250mA

42/-

Resist/valve test
Plug-in test for valves.

Complete in velvet-lined case with testing leads.

Your regular dealer can supply you, or write:

PIFCO LTD.
Watling St., Manchester.

London Address:
58, City Road, E.C.1

PIFCO

PIFCO ALL-IN-ONE A.C./D.C. RADIOMETER
The only instrument of its kind in the world for making both A.C. and D.C. tests.

RANGES: 0-6 volts, 0-240 volts, 0-30 mA. Filament and Resistance Test, and socket for plug-in test for valves. 8,000 ohms resistance. Complete with two 15-inch flex cables. Fitted with PIFCO DRY CELL.....



12/6

ROTAMETERS and RADIOMETERS
PIFCO ON THE SPOT WILL TRACE YOUR TROUBLES LIKE A SHOT

B.I. RADIO MATERIALS

We have had a long experience in the manufacture of all kinds of Cables and Wires, Aluminium Sheets and Strips, Static Condensers, Insulators and Iron Work, Telephone Cords and Copper Earthing Rods, for Radio use. Write for Radio Materials catalogue describing these and other B.I. manufactures.



BRITISH INSULATED CABLES, LTD
CABLE MAKERS AND ELECTRICAL ENGINEERS
PRESCOT, LANCS. Tel. No. PRESCOT 6571

Memo

*Don't forget
Player's
Please*

PLAYER'S NAVY CUT CIGARETTES

MEDIUM or MILD
10 for 7[⁄] 20 for 11[⁄]

NCC 495 A.

ELECTRICAL SHEETS

MOTORS AND DYNAMOS
TRANSFORMERS
ALTERNATORS
RADIO

SUMMIT
TRADE MARK

ADDRESS ALL ENQUIRIES TO
JOHN SUMMERS & SONS LTD.
SHOTTON · CHESTER
Established 1851
Tel.: CONNAH'S QUAY 200 'Grams: SUMMERS, CHESTER

Mention of "The Wireless World," when writing to advertisers, will ensure prompt attention.



Unchallengeable Supremacy

IN SHORT-WAVE RECEPTION

Short-wave radio enthusiasts should take an early opportunity of hearing "H.M.V." Model 1200 demonstrated. Its superb tonal realism and outstanding performance proclaim "His Master's Voice" supremacy in high quality reproduction. Push-button control of selected stations and waveband is allied with end control manual tuning, of particular value when making accurate loggings for short-wave listening. Its distinctive appearance and large scale will take your eye.

"HIS MASTER'S VOICE" *radio*



MODEL 1200. 3 waveband, 7-valve superhet with 10.5 watts output. It has push-button control of wavebands and 8 stations, motor operated with accurate AFC. A fluid light and Vernier scale make manual tuning exact and simple. Provision for connecting extra loudspeakers and gramophone pick-up. **21 GNS.**